

HIGH FREQUENCY APPARATUS

DESIGN, CONSTRUCTION AND PRACTICAL
APPLICATION

A PRACTICAL TREATISE
FOR ELECTRICAL ENGINEERS, ELECTRICIANS,
PHYSICIANS, STUDENTS AND EXPERIMENTERS.
COVERS THE DESIGN AND CONSTRUCTION OF
ALL KINDS OF HIGH FREQUENCY APPARATUS
FOR USE IN EXPERIMENTAL, MEDICAL AND
PLANT CULTIVATION WORK.

Includes Also

Directions for the Construction of a Complete Stage Outfit for
Both Low and High Potential Work.



BY
THOMAS STANLEY CURTIS
AUTHOR OF

"Experimental High Frequency Apparatus," "Construction of Induction Coils and Transformers," "Model Submarine With Wireless Control," Etc.

SECOND EDITION, REVISED AND ENLARGED

NEW YORK
NORMAN W. HENLEY PUBLISHING COMPANY
2 WEST 45TH STREET
1020

HIGH FREQUENCY APPARATUS

DESIGN, CONSTRUCTION AND PRACTICAL
APPLICATION

A PRACTICAL TREATISE
FOR ELECTRICAL ENGINEERS, ELECTRICIANS,
PHYSICIANS, STUDENTS AND EXPERIMENTERS.
COVERS THE DESIGN AND CONSTRUCTION OF
ALL KINDS OF HIGH FREQUENCY APPARATUS
FOR USE IN EXPERIMENTAL, MEDICAL AND
PLANT CULTIVATION WORK.

Includes Also
Directions for the Construction of a Complete Stage Outfit for
Both Low and High Potential Work.



BY
THOMAS STANLEY CURTIS
AUTHOR OF

*"Experimental High Frequency Apparatus," "Construction of In-
duction Coils and Transformers," "Model Submarine With Wire-
less Control," Etc.*

SECOND EDITION, REVISED AND ENLARGED

NEW YORK
NORMAN W. HENLEY PUBLISHING COMPANY
2 WEST 45TH STREET
1020

BY THE NORMAN W. HENLEY PUBLISHING CO.

Copyrighted 1916
BY THOMAS STANLEY CURTIS
All Rights Reserved

P R E F A C E

This volume has been prepared in response to a general demand created by a series of articles which appeared in *Electrician and Mechanic*, *Popular Electricity and Modern Mechanics*, and *The World's Advance*. The articles covered briefly the apparatus employed in an experimental study of high frequency current phenomena over a period of several years.

In this work, I have spared no effort to produce a treatise of practical value. Theory has been ignored chiefly because it would serve merely to confuse the non-technical reader. The designs offered are more than theoretical—they are the result of actual construction and experiment. In many cases, the entire oscillation transformer has been rebuilt and rewound many times before satisfactory results were obtained.

The work has been divided into six basic parts. The first two chapters tell the uninitiated reader what the high frequency current is, what it is used for, and how it is produced. The second section comprising four chapters describes in detail the principles of the transformer, condenser, spark gap, and oscillation transformer, and covers the main points in the design and construction of these devices as applied to the work in hand. The third section covers the construction of small high frequency outfits designed for experimental work in the home laboratory or in the class room. The fourth section is devoted to electro-therapeutic and X-Ray apparatus. The fifth describes apparatus for the cultivation of plants and vegetables. The sixth section is devoted to a comprehensive discussion of apparatus of large size for use upon the stage in spectacular productions.

PREFACE

I wish to acknowledge my indebtedness to the following concerns and individuals for assistance rendered in the preparation of this volume: Victor Electric Company for illustrations of standard electro-therapeutic apparatus; Clapp-Eastham Company for illustrations and the list of parts and materials; Mr. Melville Eastham for a practical working knowledge of magnetic leakage transformer design and construction; and, last, but not by any means least, Prof. Wm. C. Houghton, for many ideas and suggestions, and much unselfish manual labor during the course of experiments which made this treatise possible.

THOMAS STANLEY CURTIS.

PREFACE TO THE SECOND REVISED AND ENLARGED EDITION.

During the absence of the author of this volume, Mr. Thomas Stanley Curtis, the writer was called upon to prepare the second revised edition. The first edition of the book was made so complete and the development work done with high frequency electricity since the first edition was prepared has been so small that there was really little new matter to choose from. However, a few thousand words of Mr. Curtis' later writings on the subject of high frequency, which appeared in past issues of "Everyday Engineering Magazine," were found to be suitable and they have been included in the present edition together with their accompanying illustrations.

RAYMOND FRANCIS YATES.

July, 1920.

CONTENTS

CHAPTER I

THE ALTERNATING CURRENT AT LOW AND HIGH FREQUENCIES

Introduction. What the Alternating Current Is. Change of Frequency. Effects of Change in Frequency. The High Frequency Current. Characteristics of the High Fre- quency Current. Spectacular Demonstrations. The High Frequency Current in Medicine. Generation of Ozone and the X-Ray. Electrical Cultivation of Plants. Radio Telegraphy and Telephony	PAGE 15 to 26
--	------------------

CHAPTER II

HOW THE HIGH FREQUENCY CURRENT IS PRODUCED

Three Practical Methods. The High Frequency Alternator. Advantages and Disadvantages. The Direct Current Arc Generator. Condenser Discharge Generator. Principles Involved. The Kicking Coil Method. Limitations and Unique Advantages	27 to 30
--	----------

CHAPTER III

THE HIGH POTENTIAL TRANSFORMER OR INDUCTION COIL

Some Points in the Construction of High Frequency Apparatus. Principle of the Commercial Transformer. Transformers for Condenser Charging. How Arcing is Prevented. Develop- ment of the Eastham Magnetic Leakage Transformer. The Question of Proper Secondary Potentials. Advan- tages of Relatively High and Low Voltage. Transformer Construction. Transformer Designing. How to Calculate
--

Number of Turns, Size of Core, etc. Core Volume. PAGE
 Changes Necessary for Use on Various Frequencies. Pro-
 portions of Core. Induction Coils for High Frequency
 Work. How they Differ in Design and Proportion. In-
 duction Coil Design. Kicking Coils. What they Are. 31 to 48

CHAPTER IV

THE OSCILLATION CONDENSER

Function of the Condenser. What It Is. The Glass Plate
 Variety. Considerations of Weight, Capacity, and Space
 Occupied. A Simple Method of Determining Capacity.
 Forming a Standard Unit. Condensers for Portable Coils.
 The Use of Mica and Micanite. Relative Costs. The
 Murdock Moulder Condenser. Capacities, Sizes and
 Weights. The Oil-Immersed, Glass Plate Condenser for
 Permanent Installation. 49 to 53

CHAPTER V

THE SPARK GAP

The Simple Open Gap. Addition of Cooling Flanges. Use
 of Air Blast. The Rotary Spark Gap. Various Types and
 Advantages of Each. Number of Studs or Points Re-
 quired. Speed of Motor. Air Gap between Sparking
 Points. The Quenched Gap. Principles of Operation.
 Simple Types for Amateur Construction. Importance of
 Regulation. Characteristics of the Discharge when
 Quenched Gap is Used. The Rotary Quenched Gap. Pro-
 duction of a High-Pitched Musical Note on 60-Cycle Cur-
 rent. Advantages in Radio Telegraphy 54 to 59

CHAPTER VI

OSCILLATION TRANSFORMERS

Various Types of Air-Insulated High Frequency Current Trans-
 formers. The Simple Oudin Coil. Various Shapes and
 Proportions for the Secondary. Cones, Cylinders, Cages,
 Spirals, and the Advantages of Each. Various Primary
 Types. Round Conductor, Edgewise-Wound Copper Strip,
 Hollow Tubing, Flat Copper Ribbon, and Stranded Con-

	PAGE
ductor. Coupling. The Tesla Type of Coil. How it Differs from the Oudin. Advantages to be Gained. Tesla Secondaries. Means of Mechanical Support. Tesla Primaries. Proportions and Ratio of Diameter to Length. Combined or Double Resonator Type. Coupling. Oil and Wax Insulation for High Frequency Coils. Advantages and Disadvantages. Advantages of Close Coupling Possible. Spirally Wound and Wax Impregnated Coils for Portable Outfits. Large Oil Insulated Coils for Testing and Other Permanent Installations60 to 70

CHAPTER VII

INDUCTION COIL OUTFITS OPERATED ON BATTERY CURRENT

Ideal Apparatus for the Experimenter. Simple Oudin Resonator for Use with a Wireless Transmitter. Interesting Results Obtained with Mediocre Apparatus. Operation of the Outfit. How to Tune the Oscillatory Circuits. Induction Coil Construction. How to Build a Coil Giving a Thick, Hot Spark. Core and Primary. Insulation. Secondary Winding. Simple Winding Apparatus. Assembly. Interrupter and Condenser. Use of Silver Contacts in Lieu of Platinum. High Tension or Secondary Condenser. 71 to 85

CHAPTER VIII

KICKING COIL APPARATUS

Possibilities of this Type of Apparatus. Use on Either Direct or Alternating Current Circuit. What the Kicking Coil Is. Design for Portable Outfit Giving Seven Inch Spark. Construction of the Interrupter. The Choke Coil. Data for Cores and Windings. The Condenser. Use of Lantern Slide Cover Glasses. The Oscillation Transformer. How the Pancake Coil is Wound. Variable Primary for Tuning. Assembly of the Apparatus. Testing and Using. Electro-therapeutic Work. Construction of D'Arsonval Attachment.86 to 99

CHAPTER IX

ONE-HALF KILOWATT TRANSFORMER OUTFIT

Advantages of a Transformer for Use on Alternating Current

	PAGE
Winding. Data for All Commercial Voltages and Fre- Circuit. Design for a One-Half Kilowatt Magnetic Leak- age Transformer. Construction of the Core. Primary quencies. Secondary Winding. Assembling and Mount- ing. Oudin and Tesla Coils to Give Eighteen Inch Spark. Construction of the Coils. Condenser and Spark Gap. Connecting and Using. Protection from "Firing Back" on the Line.	100 to 113

CHAPTER X

QUENCHED GAP APPARATUS

Peculiar Characteristics of Sparks Produced with the Quenched Gap. Increase in Thickness or Volume and Decrease in Length. Production of a Flame as Thick as a Broom- stick. Design for a Practical Form of Gap. Simple Pat- terns Required. Machine Work. Assembly of the Gap. Quenched Gap Transformers. Peculiar Characteristics. Low Secondary Potential. Data for a Two-Kilowatt Quenched Gap Transformer. Specifications for All Com- mercial Voltages and Frequencies. Construction of the Transformer. Caution to be Observed. Danger of Shock from the Low Resistance Secondary Winding. Suitable Secondary Condenser. General Hints.	114 to 124
---	------------

CHAPTER XI

PHYSICIAN'S PORTABLE APPARATUS

Electro-Therapeutic and X-Ray Apparatus. Requirements of the Ideal Outfit. Good Workmanship Required. Dangers of a Short Circuit Within the Cabinet. Importance of Establishing Confidence of the Patient. Transformer Out- fit not Practicable for Amateur Construction. Design for Kicking Coil Outfit Within Reach of Builder. Standard Electro-Therapeutic Apparatus. Various Types and what they Cost. Possibilities and Limitations. Special Direct Current Outfits. Apparatus Suitable for Dentists. Large Portable Outfits. Technical Description and Capabil- ities	125 to 131
--	------------

CHAPTER XII
PHYSICIAN'S OFFICE EQUIPMENT

	PAGE
Powerful and Efficient Equipment for the Physicians' Office. Design for a One-Kilowatt Outfit with Apparatus Mounted upon a Table. Advantages of this Form of Construction. Imposing Appearance. Accessibility of the Component Parts. Construction of the Magnetic Leakage Transform- er. Rotary Spark Gap. Stationary Spark Gap. Oscillation Condenser. Transformer for Vacuum Tube Work. Oil- Immersed Oscillation Transformer for X-Ray Work. D'Arsonval Treatment Transformer. Assembly of the Ap- paratus. Connecting and Using.	132 to 144

CHAPTER XIII
A PHYSICIAN'S OFFICE EQUIPMENT MADE WITH
STANDARD MATERIALS

Design. Explanation of Operations. Directions for Making High Frequency Transformer. Construction of Cabinet. Coil for Thermo. Faradic Currents. Price of Materials Necessary. Design of Impedence. Use of Apparatus.	145 to 159
--	------------

CHAPTER XIV
HOT WIRE METER CONSTRUCTION

Principle of the Hot Wire Meter. Ease and Cheapness of Construction. Measurement of Both Low and High Fre- quency Currents with One Instrument. How to Build a Simple Hot Wire Meter. Calibration and Use.	160 to 165
---	------------

CHAPTER XV
NOTES FOR THE BEGINNER IN ELECTRO-
THERAPEUTICS

Discussion of the Apparatus and the Principles upon which It Operates. Relation of Transformer to the Condenser and Oscillatory Circuit. The High Potential or Tesla Current. Physiological Effects of the High Frequency Current. Re-	
---	--

	PAGE
duction of Blood Pressure. Treatment of Diseases of the Skin and Scalp. True Merit of the High Frequency Current in the Practice of Medicine. Stimulation of the Growth of Hair. Restoration of the Original Color to Grey Hair. Cumulative Effects. The Value of Persistent Administration,	166 to 171

CHAPTER XVI

PLANT CULTURE WITH HIGH TENSION CURRENT

Practical Electro-Horticulture or the Cultivation of Plants with Electricity. Scarcity of Available Data. Investigation Mostly Private. Great Progress Made by Agricultural Departments of Schools and Colleges. The Art in the Experimental Stage. Electro-culture Methods. High Tension. Direct Current. High Tension, Low Frequency Alternating Current. High Frequency Alternating Current. Cultivation of a Bed of Lettuce. The Aerial Conductor. Caution Must Be Observed. Construction of the High Potential Transformer. Data for All Commercial Voltages and Frequencies. Assembly of the Apparatus. Actual Results Obtained. Report on Experiments at the Moraine Farm. Table of Comparative Results Obtained with Various Processes of Electro-Culture.	172 to 181
--	------------

CHAPTER XVII

HIGH FREQUENCY PLANT CULTURE

Generation of High Frequency Current for Long Continued Periods of Time. The Problem Involved. Careful Workmanship Essential. Construction of the Generating Apparatus. Data for Various Commercial Voltages and Frequencies. Building of the Transformer. Assembling and Mounting. Construction of the Condenser. Provision for Cooling. The Self-Cooling Spark Gap. The Oscillation Transformer. Installation of the Apparatus. The Transformer Shed. Switches and Control Devices. Protection from Accidental Shock. Wiring the Plot to be Cultivated. Ground Connection and Overhead Net Work. Operation of the Apparatus. Time of Treatment. Value of Comparative Data	182 to 203
---	------------

CHAPTER XVIII

FURTHER NOTES ON PLANT CULTURE

	PAGE
How to Use a Standard Radio Transmitter for Plant Culture Work. The Distributing System. Construction Difficulties. Making Wire Net Work. Vegetables to Plant. Apparatus Required. Mushroom Growing.	204 to 211

CHAPTER XIX

A FOREWORD ON THE CONSTRUCTION OF ELECTRICAL APPARATUS FOR THE STAGE

High Tension Electrical Stagecraft. Opportunities of High Potential Electricity for the Professional Entertainer. Chance to Improve upon Past Offerings. Importance of High Frequency Apparatus. Points to Consider before Starting Work. Cost and Weight of Apparatus. Difference Between the Lecturer and the Vaudeville Artist. Current Required and Difficulties of Obtaining It. Where and How to Build the Apparatus. The Home Workshop and Its Equipment. Some Work Done Outside if Large and Expensive Tools are not Available. Advantages of Doing Work at Home. Working Drawings and Blueprints. Need for Practical Working Knowledge of Subject. How to Obtain this Knowledge. Mathematics Unnecessary.	212 to 217
--	------------

CHAPTER XX

CONSTRUCTION OF LARGE HIGH FREQUENCY APPARATUS

Design for a Resonator Producing a Five-Foot Spark. Details of Construction. Building the Secondary Cylinder. The Winding. Building the Primary. Assembly of the Coil. Connecting Cable and Clips. The High Potential Transformer. Design for a Four-Kilowatt Magnetic Leakage Instrument. Building the Core. Forms for Winding Primary and Secondary. Insulation. Assembly of the Transformer. Construction of the Rotary Spark Gap. Spark Gap Muffler. The Oscillation Condenser. Coating the Plates. Building Up Units. Connections. Setting Up
--

and Operating the Apparatus. The Switch Board. Pre- vention of Kick Back. Tuning and Adjustment of the Apparatus.	PAGE 218 to 238
---	--------------------

CHAPTER XXI

LARGE TESLA AND OUDIN COILS FOR THE STAGE

Specifications for Large Oscillation Transformers of the Port- able Air-Insulated Type. Tesla Transformer for the Pro- duction of a Fifty-Inch Spark. Details of Construction. Oudin Resonator for the Production of a Short but Very Thick Discharge. Mounting the Apparatus. Provisions for Packing and Shipment.	239 to 246
--	------------

CHAPTER XXII

CONSTRUCTION OF A WELDING TRANSFORMER

Transformer to Deliver a Current of Low Voltage and very Great Amperage. Heating a Quarter-Inch Iron Rod to Incandescence. Building the Transformer. Suggestions for Handling the Heavy Secondary Wire. Insulation. Assembly and Mounting. Experiments Using a Current of 250 Amperes. Special Copper Tongs or Pliers. Making Flexible Cable to Carry the Heavy Current. Burning Up a Heavy Bar of Steel. Welding Two Pieces of Iron Rod Held in the Hands. Spot Welding of Sheet Iron. Melt- ing Metals in a Crucible to Show Principle of Electric Furnace. Suggestions for Effective Stage Setting. Par- ticularly Startling and Spectacular Experiments to Close the Entertainment.	247 to 255
---	------------

CHAPTER XXIII

HINTS FOR THE ELECTRICAL ENTERTAINER

Preparation of the Lecture. Snap and Vigor Necessary. Edu- cation of the Public Far Advanced in Recent Years. Class of Audience Must Receive Careful Consideration. Com- parison of Well-Read Chautauqua Assembly with Audience Found in High Class Vaudeville Theatre. Vaudeville Au- dience Demands to be shown. Experiments must Speak
--

	PAGE
for Themselves. Method of Presentation for Typical Lecture Audience. Touch of Comedy of Great Value with Theatre Audience. Short Introduction Preferable. Impressive Opening Necessary. Suggestion for Successful Program. "Trying it on the Dog." The Matter of Rehearsals. Selection of Experiments. Time of Act. How to Present the Offering on the Stage or Lecture Platform. Specimen Program with Outline of Experiments and Lecture.	256 to 263
Useful Tables	264 to 266

THEORY OF THE ...

... the ...



... the ...

... the ...

... the ...

CHAPTER I.

THE ALTERNATING CURRENT AT LOW AND HIGH FREQUENCIES.

While the manuscript for this book was being prepared, the author was approached by a caller who introduced himself as an enthusiastic experimenter and a reader of all manner of practical books. This gentleman explained that he was an armature winder by trade, and that he wished to take up high tension work solely as a hobby. He was possessed of but little knowledge of mathematics and had been unable to understand the many books on transformer design and construction that he had purchased.

A few minutes' conversation with this caller brought to light some important points which since have prompted a radical and wholesale change in the method of treatment. Half a dozen pointed questions suggested the introduction to the general subject that is offered in the next few paragraphs.

What the Alternating Current is.—An alternating current is one that periodically changes its direction of flow a certain number of times per second. It is the reverse of the direct current which is assumed to leave the battery or dynamo at the positive pole and return by way of the negative pole. With the alternating current, the terminals of the machine are alternately positive and negative. This characteristic is well shown in the diagram, Fig. 1, which may be assumed to show the course taken by a current leaving

the terminals of an alternating current generator having four field poles and having its armature or "rotor" driven at 1800 R.P.M. This machine would be termed a 60-cycle alternator because the current it delivers would make 60 complete cycles or 120 alternations in a space of one second.

With reference to Fig. 1, let us assume that *A* represents the current as it starts from one collector ring of the machine. Following the direction indicated by the arrow, we find the current rises in voltage until it reaches its peak at *B*. The value then falls back to zero as the current returns to the other collector ring, *C*. At this point the arma-

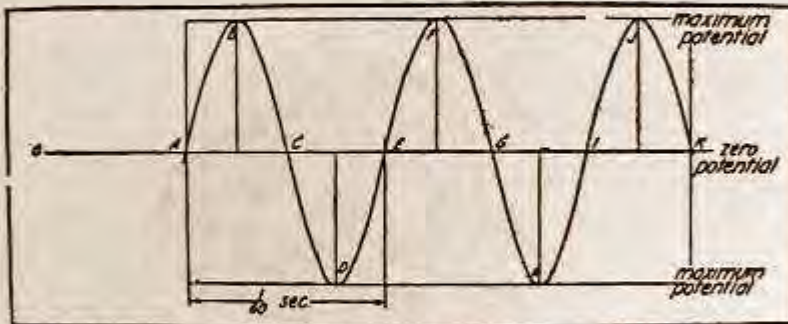

Fig. 1.—Diagram showing how an alternating current periodically reverses its direction of flow

ture or rotor of the machine passes to the next set of field or stator poles and the current starts out over its circuit again, but in the *reverse* direction. For convenience, this is shown as below the zero line in the illustration. Leaving *C*, the current rises to the maximum at *D* and then returns to *E*.

The period of time taken in the passage from *A* to *E* is just $1/60$ second; in this space of time the current has made a complete *cycle* of two alterations, one in a positive

and the other in a negative direction. In one second of time, it will have made 60 complete cycles; it is therefore called a 60-cycle current.

Change of Frequency.—Now let us assume that the alternator be supplied with eight field or stator poles instead of four. As a reversal of current occurs when the rotor windings pass from the influence of one pair of stator poles to the next pair, it is obvious that to double the number of stator poles is to double the frequency, if the speed at which the armature is driven remains the same in each case. On the other hand, precisely the same result is obtained if the number of poles remains fixed and the speed of the rotor is doubled. Therefore, the matter sums itself up into a simple formula which will be useful to the worker if he will but understand it and not fear it as some intangible form of "mathematics." The formula is:

$$\text{Frequency} = \frac{2 \times 60}{\text{R.P.M.} \times \text{Number of Poles}}$$

Therefore, if we know the number of poles of a given machine and the speed at which it is driven, we may multiply the number of revolutions per minute by the number of poles and divide this product by 120 to find the frequency of that particular machine.

On the other hand, suppose we know the number of poles and we are required to produce a certain frequency from a given machine; we must determine the number of revolutions at which the rotor must be driven. This formula is:

$$\text{R.P.M.} = \frac{2 \times 60 \times \text{Frequency}}{\text{Number of Poles}}$$

To simplify the first formula into a form where it is ready for use at a moment's notice without any calculation, we may say that the number of cycles per revolution will be equal to the number of poles divided by 2. To use this, let us take the case of the four pole machine. Four divided by 2 is 2. Therefore, the machine will deliver two cycles to every complete revolution of the rotor. If the speed is 1800 revolutions per minute or 30 per second, the frequency is 2 times 30 or 60 cycles per second.

Effects of Change of Frequency.—For commercial use such as lighting lamps and operating motors, the 60-cycle

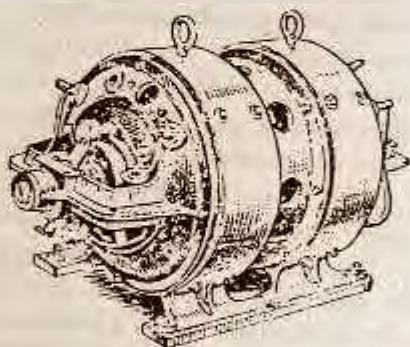

Fig. 2.—A motor-generator for changing direct current to alternating current

current is in general use in the United States. Certain parts of the country still use 125 and 133-cycle currents and in Canada the 25-cycle current is much in evidence.

A change in the frequency of the current necessitates profound changes in the apparatus it is intended to operate. It is not within the province of this work, however, to touch upon the alterations necessary in motors in order that they may be adapted for various frequencies. Suffice it to say that in the case of transformers, which are closely identified with the apparatus described, any change

in the frequency of the current necessitates a corresponding change in the windings of the transformer.

Generally speaking, one of the higher frequencies is to be preferred for transformer work, for the core may be lighter and smaller, and the instrument is consequently cheaper and easier to build. Therefore, if the worker intends to generate his own alternating current, he may well employ an alternator producing a 120-cycle current at moderate speed. As a rule, however, some form of alternating current supply is available and, in such event, the experimenter will, of course, find it cheaper and better to so design his apparatus that it will operate in a satisfactory manner on the circuit at hand.

In the various descriptions of transformers which follow in later chapters, the data for all standard frequencies are given in order that the worker need not make computations unless he so desires. In addition to this, one entire chapter is devoted to a simple explanation of the principles of transformer design, and, from this explanation, the average worker will be enabled to work out any special design that may appear desirable.

In the case of direct current supply a motor-generator of the type shown in Fig. 2 is sometimes used. This consists of an alternating current generator driven by a direct current motor. Both armatures are mounted on the same shaft in the machine illustrated.

The High Frequency Current.—When an alternating current is made to change its direction of flow many thousands of times per second, it is termed a "high frequency current." The precise figure at which this term is properly applied is not very clearly defined but it is usually placed at the mark of 10,000 cycles per second. From this, it may extend into the hundreds of thousands or perhaps millions of cycles per second. How this current, which os-

cillates with such inconceivable rapidity, its produced will be duly explained in the next chapter, but first of all let us consider the peculiar characteristics of which it partakes and the uses to which it may be put.

Characteristics of the H. F. Current.—For the serious experimenter and student of modern electricity, there is no more fascinating study than that of the electric current at high potential and high frequency. The phenomena which may be exhibited through its agency are at once spectacular and startling, of inconceivable beauty and grandeur, and, in practical applications, of the greatest utility and importance. While the larger types of apparatus demand that the utmost care and the finest materials be used in the construction, the youthful experimenter may satisfy his craving for immediate results by building temporary apparatus of the crudest construction imaginable and still obtain effects bordering upon the marvelous.

When the electric current is made to oscillate or change its direction of flow several thousand times per second, it partakes of some astonishing characteristics. All of the preconceived theories of electricity as applied to the commercial current are overthrown and the phenomena exhibited are contradictory in the extreme to the conventional ideas of the everyday electrical worker. For example, if an alternating current of the commercial sort having a frequency of 60 or 125 cycles per second, be passed through the human body, a muscular contractive effect is produced and the sensation of an electric "shock" is felt. If the voltage of the applied current should be higher than the hundred mark, the shock is unpleasant and perhaps dangerous; let it reach 1,000 volts or perhaps even half that amount, and the shock is in most cases fatal. On the other hand, if the current be made to oscillate or change its direction of flow with a frequency of 10,000 or more cycles per sec-

ond, it may be applied to the body without danger or even discomfort at potentials running well into the tens of thousands. Let the frequency be increased still further, say into the millions, and the sensation of shock and muscular contraction is quite absent. Its place is taken by one of gentle warmth.

Spectacular Demonstrations.—The importance of this one peculiarity alone will be appreciated by those who have seen the self-styled electrical marvels upon the stage. Their claims to the effect that they are "taking thousands of volts through their bodies" are perhaps well founded for the presence of a spark several inches long is pretty good evidence of a very high potential. It is usually conceded that every inch of spark between points through the air represents a potential of between fifteen and twenty-five thousand volts. The secret of the performer's apparent power rests solely with the high frequency current.

Perhaps the reader has seen one of these entertainers charge the body of an assistant to the point where a spark several inches in length may be drawn from the fingers, chin, elbow, or even the tongue. A tuft of cotton or tissue paper held in the spark is immediately ignited, or perhaps the performer may light the tip of his cigarette with the spark taken between his finger and the body of the assistant. Possibly the performer may grasp the terminal of his machine with one hand while the other holds a wire leading to an ordinary incandescent lamp; the assistant touches the remaining terminal of the lamp and the current is turned on. The lamp filament becomes red and perhaps white hot, finally burning out completely with the current passed through the bodies of the performer and his man.

The stage may be darkened and the terminal of the apparatus connected with the body; as the current is turned on, the extremities of the body are seen to glow with a

weird blue light. As the hand is raised above the head, streamers of purplish fire dart from the finger tips. A vacuum tube brought to within a distance of several feet from the body lights up with its characteristic glow even though there is no connection with the performer's body or the apparatus.

All of these experiments and hundreds of others may be performed with comparatively simple and inexpensive apparatus that is well within the reach of the average amateur mechanic. If the reader aspires to greater heights, he may build apparatus with which great, long sparks may be produced.

The High Frequency Current in Medicine.—The high frequency current, when applied to the human body through suitable electrodes and other appurtenances, can be made to produce the most profound physiological effects. Applied through a glass electrode from which the air has been exhausted, the current stimulates the circulation of the blood, bringing it to the surface and increasing nutrition. Persistent application of the vacuum electrode to the scalp at certain intervals will restore the original color to grey hair. On the scalp of a partially bald patient, repeated applications will promote the growth of new hair if the roots have not been totally destroyed.

Placing the patient in a chair having a metallic plate beneath its seat and behind the back, the physician may administer the high frequency current in the form of treatment known as auto condensation and thereby reduce the blood pressure in cases of arteriosclerosis. The same treatment is being successfully used in the reduction of superfluous flesh.

The general effect on the patient is a tonic one and in practically every case reported, the patient has been brightened up, given added vigor and cheerfulness, and, in

fact, has exhibited all of the favorable effects of a powerful tonic without sustaining any of the unfavorable after effects of a stimulant.

While on the subject of the medical application of the high frequency current, it may be well to point out the fact that while no ill effects are likely to be experienced from the treatment in the hands of an unskilled operator, continued applications intended to produce a medicinal effect upon the body should certainly not be given by the layman without first having had the advice of a physician. The two primary modes of treatment, *i. e.*, the vacuum electrode and the auto condensation, produce diametrically opposite effects. The electrode treatment tends to increase the blood pressure while the auto condensation tends to reduce it. It is obvious, therefore, that the auto condensation should never be applied except in cases where normal or hyper tension is indicated. After the examination has been made and the treatment prescribed, there is no reason why the actual administration should not be given by the layman if the physician keeps a watchful eye on the progress at suitable intervals between treatments.

The Generation of Ozone and the X-Ray.—For the physician or the experimenter, there is perhaps no form of X-Ray apparatus better adapted to light office or laboratory use than the high frequency coil. It is safe, convenient and powerful and for all cases where very short exposures through the heavier portions of the body are unnecessary, it will meet the requirements admirably. True, the X-Ray is never quite safe in the hands of anyone other than a skilled operator having years of experience on his shoulders. The ray generated by a tube excited with a high frequency current is, however, less liable to produce the characteristic burn than is that produced by any other means. Just why this is so, is not definitely known, but the experience

of the past few years indicates beyond a doubt the truth of the statement.

A high frequency coil to produce an eight-inch spark of a quality adapted to light X-Ray work can be built in the home workshop at only a fraction of the cost of an induction coil to do the same work. Furthermore, the high frequency apparatus is simple in construction and operation and it can be depended upon to do its work without the annoying delays incident to the usual induction coil with its troublesome interrupter and the ever-present danger of a serious breakdown of the insulation.

As a generator of ozone for medicinal purposes, the high frequency coil is particularly energetic and efficient. When the discharge terminals of the coil are separated beyond the normal sparking distance, great volumes of ozone are liberated in the space filled with a crackling brush discharge. When the vacuum tube electrode is passed over the body, the ozone is liberated at the point of contact. For purposes of inhalation, a simple apparatus consisting of a vacuum electrode surrounded by an outer wall of glass with an air space between can be made to produce the gas in ample quantities and with the additional advantage that it may be collected and administered to the patient through a suitable rubber tube and mouthpiece. Furthermore, this simple appliance permits one to pass the gas through a small quantity of oil of eucalyptus which tends to remove the nitrous oxide that invariably accompanies ozone generated by the electric spark.

Electrical Cultivation of Vegetation.—The high frequency current, when sent through a network of wires above a plot of ground, has the peculiar property of stimulating the plant life in the earth beneath the wires. Just why this should be so is not definitely known; while various theories have been advanced, it is possible that one and

all may be faulty and it is not within the province of this book to offer theories. The apparatus required for the cultivation of plants on a small scale is neither elaborate nor costly although it must be made rather rugged in electrical construction to withstand the strain of almost continuous operation for hours at a time.

In a later chapter the data for the apparatus required for the cultivation of a one acre plot in the open is given; in addition to this, notes on the conduct of experiments with potted plants indoors are given as are also a few suggestions for hot-house work with both vegetables and flowers.

The electrical cultivation of plants is entirely practical if a source of cheap electric power is available. On the small farm where water power or even gasoline engine power is developed, the electric current may be generated at very low cost in quantities sufficient for practical work.

The experiments have their commercial side as well as their purely experimental. Crops may be forced to an early maturity with a marked increase in the flavor and tenderness. Lettuce is particularly susceptible to the influence of the current, while radishes and beets follow closely. For fancy fruits and vegetables the process is productive of results which add materially to the profits ordinarily to be made.

Radio Telegraphy and Telephony.—Beyond a doubt, the most popular and the best known application of the oscillatory current is in the field of radio telegraphy and telephony. Every village seems to have one or more amateur wireless telegraphs.

The oscillatory current, when vibrating within a certain range of periodicities, sets up electromagnetic waves in the ether if it be sent into an aerial or overhead wire which is insulated from the earth. These waves, which resemble light waves in point of speed but which are quite invisible,

are radiated in all directions at a pressure of the radio telegraph key.

The apparatus described in this book is admirably adapted for purposes of radio telegraphy and some of the transformers, condensers and spark gaps represent the best and most modern practice in the construction of radio transmitters.

CHAPTER II.

HOW THE HIGH FREQUENCY CURRENT IS PRODUCED.

There are but three practical methods by means of which the high frequency current may be generated. In one of these methods, an alternating current generator having a very large number of stator pole pieces is employed; this is essential in order that the speed at which the rotor must be driven may be kept within reasonable limits. Even so, the speeds of most of the experimental machines built thus far have been as great as 10,000 R.P.M. and the reader's practical knowledge will doubtless tell him that a heavy, composite mass of metal, driven at this speed, introduces complications that are very likely to result disastrously should anything go wrong. The maximum frequency obtainable by this method is about 100,000 cycles per second and this frequency, with a useful output of current, is to be obtained only through the use of a very costly and dangerous machine. The high frequency alternator method, while it undoubtedly possesses some positively unique advantages in radio telegraphy and telephony, is scarcely a piece of apparatus that comes within the scope of this book.

The second method is by means of the direct current arc. When an ordinary arc is shunted by a suitable capacity and inductance, oscillations are set up in the circuit. A secondary added to the primary inductance or helix will

have induced in it a high frequency current similar to that oscillating in the primary circuit. By means of a suitable adjustment of the ratio existing between the turns in the two coils, the potential delivered at the secondary terminals may be increased practically at will.

The most familiar use of the arc as a high frequency current generator is in the field of radio telephony. The purity of the wave generated by the arc renders it particularly well adapted to this use. For purposes of demonstration, however, the arc generator is not capable of delivering a sufficiently large output. With all due respect to the method in the work for which it is best adapted, we shall therefore recommend that the experimenter discard it, using in its stead, the condenser discharge form of generator, a detailed description of which follows.

Condenser Discharge Generator.—It is assumed that the average reader of this book will be familiar with the elementary principles of wireless apparatus. Granting this, it is, of course, reasonable to believe that such readers will understand how an oscillatory current is set up in a circuit comprising an inductance or coil of wire, a capacity or condenser, and a spark gap. The condenser is charged with a high tension current from any convenient source such as a transformer or induction coil, and when the potential stored up in the condenser reaches a critical value, the air in the gap between the spark gap electrodes can no longer stand the strain, and the condenser discharges across the gap in a succession of crashing sparks. As the current from the condenser crosses the gap in one direction, it literally over-reaches itself just as a pendulum swings past the neutral point when given a push with the hand. When the first rush of current passes in one direction, a reversal of the cycle occurs and a second rush in the opposite direction is effected. This operation is repeated many thou-

sands of times per second, the discharge gradually dying down until the potential across the condenser has been lowered to such an extent that the spark can no longer jump the air gap. The Condenser immediately takes a fresh charge from the transformer and the entire cycle of operations is repeated. It will be understood that all of this passes in an infinitesimal fraction of a second, the charge and discharge of the condenser taking place so rapidly that the observer can detect no change in the solid spark which appears continuously to fill the gap.

As the current surges back and forth through the inductance, which is merely a coil of a few turns of very heavy wire, a similar current is induced in a second coil of wire placed in the same plane as the first. A slight increase in the number of turns in the secondary over those in the primary will result in a very large increase of potential between the secondary terminals.

Unlike the low frequency or commercial transformer the high frequency or oscillation transformer requires no iron core whatever; indeed, the presence of iron in the center of the windings is not to be considered as it would be detrimental to the successful operation of the transformer.

From this the reader will note that in order to produce a high frequency current of practically any desired potential it is only necessary to combine two coils of insulated wire of the proper proportions and number of turns with a conventional transformer, condenser and spark gap.

The Kicking Coil Method.—The operation of a high tension transformer for the charging of a condenser necessitates an alternating current. There are certain cases wherein it is desirable to produce a high frequency current where direct current only is available. This is particularly true in the case of electro-medical apparatus which must frequently be used at the patient's bedside. For this type

of apparatus, a simple modification of the condenser discharge principle is available. This method utilizes what is known as a "kicking coil."

A kicking coil is a solenoid of coarse copper wire wound upon a laminated iron core. If a direct current be sent through this winding, and the circuit broken suddenly, a pronounced flash will occur at the break of contact. The high potential represented by this flash is induced by the self-induction of the coil wound on the iron core. Under favorable circumstances the instantaneous voltage generated may reach from several hundred to considerably over a thousand volts. This potential is, of course, quite sufficient to charge a condenser, and it is only necessary to provide some suitable means for rapidly making and breaking the circuit with condenser and inductance in series in order to generate a high frequency current quite similar to that produced with the apparatus described in the preceding section.

Experiment has shown that a substantial vibrating interrupter with heavy silver contacts serves the purpose admirably. The vibrator is actuated by means of the magnetism in the core of the kicking coil.

CHAPTER III.

THE HIGH POTENTIAL TRANSFORMER OR INDUCTION COIL.

As the reader will have inferred from the preceding chapter, the condenser discharge principle is employed in the construction of all of the apparatus described in this work. While the use to which each particular outfit is to be put governs, in a large measure, the actual construction and design of the component parts of the apparatus, the basic principle is quite the same in each case. Granting this, each outfit will comprise the following units:

The Transformer or Induction Coil which converts the low voltage current available from the lighting circuit, or perhaps a battery, into a high voltage current suitable for charging.

The Condenser, which is composed of alternate sheets of metal and glass or other material having a high dielectric value. The condenser discharges its load of electric current at high pressure across

The Spark Gap, which is composed, essentially, of metallic electrodes, having accurately turned faces held in the same plane by means of suitable supports. In series with the spark gap and condenser is the primary of

The Oscillation Transformer, which comprises two coils or helices of copper wire. One of these coils, the primary, is composed of a few turns of thick wire, while the secondary may have from ten to one hundred times as many turns of fine wire.

A few general suggestions relative to each of these units and their relations one to the other will, it is believed, be conducive to a clearer understanding of the detailed directions which follow in later chapters. No attempt will be made, in the present chapter, to offer details of construction such as dimensions of the parts, as this feature is covered specifically in the directions given in succeeding chapters, each of which is devoted to a complete description of a certain type of outfit. The object of the general information in this and the following chapter is to afford the reader, who has delved but slightly into the intricacies

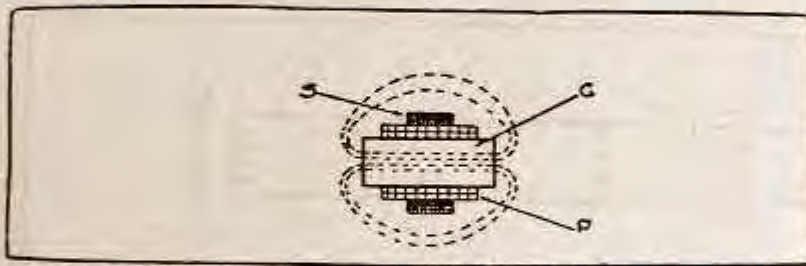

Fig. 3.—Simple open core transformer. Core is represented by *C*, primary by *P*, and secondary by *S*.

of high tension electrical work, an intelligent insight into the basic principles of design and construction of the several units which comprise the outfit.

Transformers.—The transformer is essentially an alternating current device. In its simplest form, it consists of a core, *C*, Fig. 3, of laminated iron, a primary winding of insulated copper wire, *P*, and over this a secondary winding, *S*, also of insulated copper wire. An alternating current sent through one winding induces a similar current in the second winding. A variation in the ratio existing between the turns of the two coils, produces a corresponding change in the induced voltage.

Such a transformer is known as an "open core" instrument because the magnetic lines of force set up in the straight iron core must reach around through the air as shown in Fig. 3 to complete the magnetic circuit. A modification is shown in Fig. 4 which illustrates a method by means of which the windings of the transformer are partially surrounded by iron. This provides a ready path for the lines of force with a large increase in the efficiency of the instrument. Such a transformer is said to have a closed core.

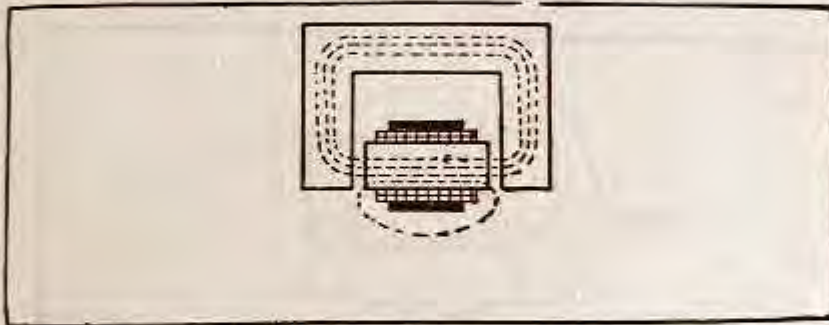

Fig. 4.—Showing principle of closed core transformer. Lines of force pass through the closed magnetic circuit instead of through the air as in Fig. 3.

There are many modifications of the closed core transformer, all of which have merits peculiar to the uses to which they are put. For lighting and power work, it is desirable to have the primary and secondary windings as closely "coupled" as possible and to this end most power transformers have very compact cores which almost cover the windings. The effect of this close coupling is to improve the "regulation" of the transformer, *i. e.*, to reduce the fluctuation in voltage from no load to full load to a minimum. This type is shown in Fig. 4.

Transformers for Condenser Charging.—In the early days of radio telegraphy, when transformers were first used

for the charging of condensers, the experimenter knew but little of the requirements of the process. The only high tension transformers available were of the power variety with closely coupled primary and secondary, and the first trials of these gave such promising results that the workers were induced to carry on an extensive line of research with a view to improving the apparatus.

One great difficulty was experienced from the start. A glance at Fig. 5 shows that the secondary terminals of the transformer are shunted by the spark gap, which in turn is shunted by the condenser and primary of the oscil-

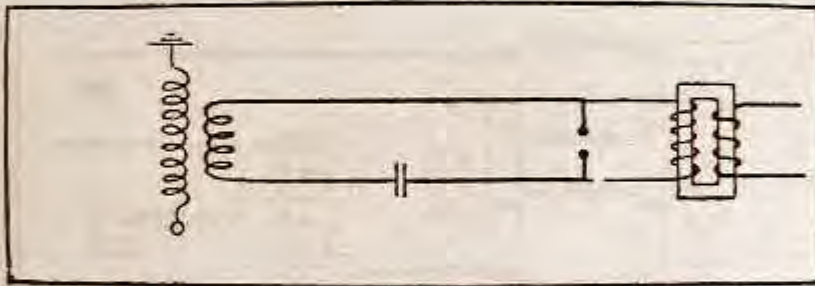

Fig. 5.—Typical oscillatory circuit showing how high frequency current is generated by means of the condenser discharge method

lation transformer in series. When the condenser discharges across the spark gap, the discharge produces a short circuit for the secondary current in the transformer after the spark has died away. This causes an arc to form with the result that the condenser cannot charge again as it should. The close coupling of the windings tends to hold the secondary voltage at its maximum when the short circuit occurs.

Various experiments were tried to prevent the formation of the arc, and among these may be mentioned a magnetic blow out, which aided in quenching the arc; a blast

of compressed air between the spark gap electrodes, which literally blew out the arc as soon as it formed; and various devices which mechanically separated the electrodes to a point where the arc was extinguished. The most familiar form of the latter device is the common rotary spark gap.

As the work progressed, the experimenters discovered that by placing an impedance coil, consisting of a single winding of copper wire on an iron core, in series with the primary of the transformer, the arcing was materially les-

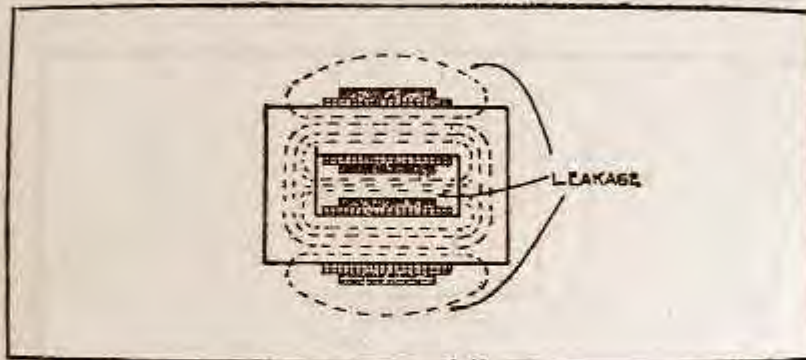

Fig. 6—Typical closed core transformer arranged for power and lighting circuits. Close coupling of primary and secondary prevents excessive drop in secondary voltage when load is applied

ened and the various blow-out devices were rendered unnecessary to a certain extent. This procedure is illustrated in Fig. 5, which shows the impedance coil in series with the primary of the transformer, the windings of which are closely coupled. This was the first step in the direction of the celebrated "Type E" wireless transformer which was patented by Mr. Melville Eastham and which has been copied in various forms by dozens of manufacturers since its introduction.

The design of the "Type E" transformer introduces the

very quality that the makers of power transformers seek to avoid, namely, magnetic leakage in the core. When the secondary of such a transformer is short circuited by the spark, the potential instantly drops to so low a value that the arc dies out of its own accord; indeed, it is doubtful if any appreciable arc forms at all.

The principles of the magnetic leakage transformer are shown in Figs. 8, 9 and 10. In Fig. 6, the primary and secondary are seen to be mounted upon separate legs of the rectangular iron core. This loosens the coupling to such an

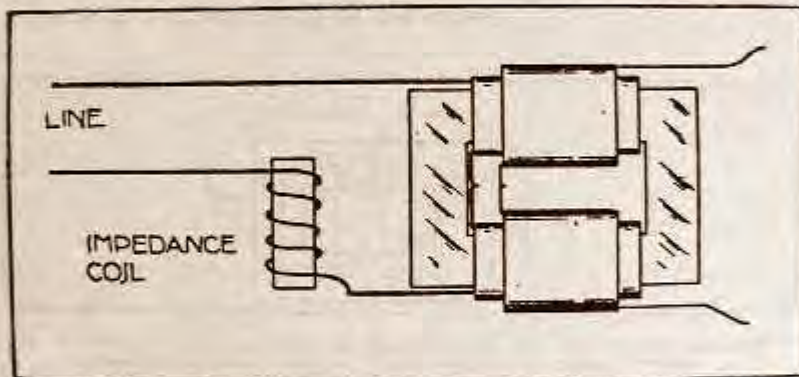

Fig. 7.—Transformer with closely coupled primary and secondary and the impedance coil in series with primary to prevent arcing at spark gap

extent that magnetic leakage is set up in the space between the windings and around the outside of the core as shown by the lines in the drawing. This leakage diverts a portion of the total flux from its path through the cores inside the windings, and when the abnormal load comes on the secondary, the potential suffers a tremendous drop as the regulation is intentionally poor.

In Fig. 9, the primary and secondary are still farther separated by being placed upon the short legs of the core instead of the long ones as shown in the preceding figure.

This is carrying the point still farther. In Fig. 10, we have the true Type E instrument in which a tongue of iron projects from one leg of the core between the windings, and nearly makes contact with the opposite leg. This introduces a partial magnetic shunt that serves every purpose of the external impedance coil and which has some marked advantages over the latter device.

With a correctly proportioned magnetic leakage transformer, brought to resonance by a suitable condenser connected in the oscillation circuit, the arcing at the gap is

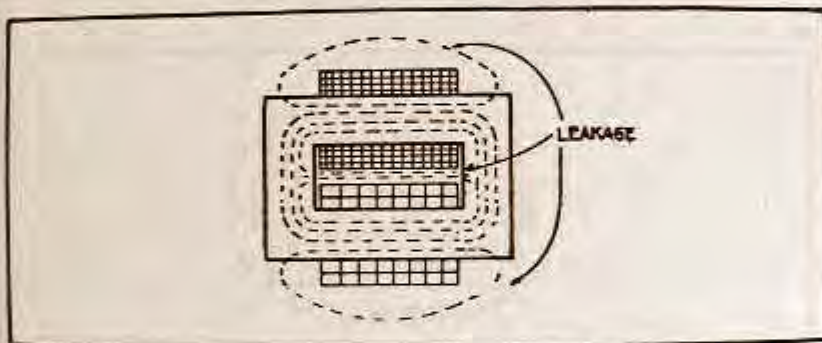

Fig. 8.—Transformer with primary on one leg and secondary on other leg of core to introduce greater magnetic leakage. The first step in the development of the resonance type of transformer

reduced to a minimum and the discharge partakes of a clear ringing tone not to be heard in other types of equipment.

In addition to this marked advantage, the magnetic leakage transformer can be made to attain a degree of efficiency and a power factor not possible in the ordinary combination with its impedance coil.

Secondary Potentials.—The proper potential for the secondary in the case of the resonance transformer (the term that will henceforth be applied to the low-frequency

alternating current transformer designed for condenser charging) will depend upon the condenser with which it is to be used and also upon the type of spark gap employed. Since the introduction of the Federal radio telegraphic laws which govern the wave length of amateur stations, the tendency has been in the direction of higher potentials for wireless telegraphic work. The higher potential permits a smaller condenser to be used. For other high frequency work, however, there is no particular advantage to be derived from the high voltage secondary and its use involves certain electrical and mechanical difficulties that are expensive and annoying to surmount.

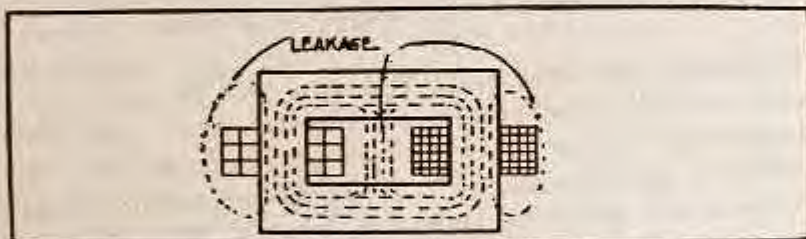

Fig. 9.—Primary and secondary on short legs of core and widely separated to increase magnetic leakage. This construction renders external impedance coil unnecessary.

The most satisfactory potentials, in the authors experience, have been from 4,000 up to 12,000 in transformers ranging in size from $\frac{1}{4}$ k.w. to 3 k.w. This range of potential, with a .03 mfd. condenser has been found quite suitable in the construction of many sets of apparatus.

With the quenched type of spark gap, a totally different condition is met. Secondary potentials as low as 900 to 1,000 volts are excellent in the case of small transformers of capacities ranging from $\frac{1}{4}$ to $\frac{1}{2}$ k.w. For the larger sizes, the potentials may run up from 2,000 to 3,000 volts. The quenched gap, which will be specifically described

later, is exceedingly short and a much lower potential is, accordingly, in order.

Transformer Construction.—In each chapter of this book, wherein a set of apparatus is described, the complete specifications for the construction of the transformer are given. The object of this discussion will, therefore, be to cover only briefly the essential principles of the construction.

The transformer core in each case should be of thin sheets of silicon steel, .014 in. thick, and made expressly for use in transformers and other alternating current apparatus. It is practically as cheap as the so-called transformer

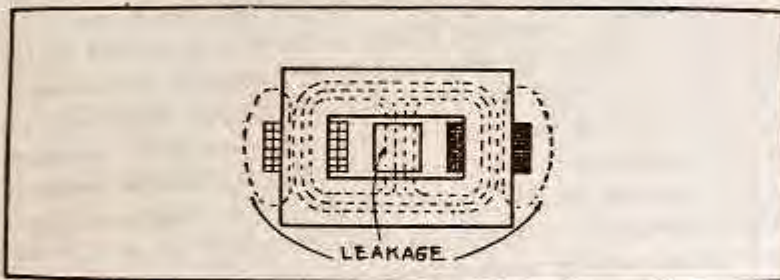

Fig. 10.—Type E transformer with tongue of iron to increase magnetic leakage between windings

iron and, if results count, it is much cheaper than stove-pipe iron.

The construction of the core is simple. The silicon steel can be bought in sheets or, preferably, in pieces cut to size and ready to assemble. The rectangular pieces are placed one upon the other to make piles of the required thickness for the assembled core and then firmly gripped with a binding of tape.

The windings are made on simple wooden forms, either in a lathe or else on a hand winding device. The winding is invariably that known as the layer method. The "pie"

winding, described in so many of the older books on radio construction, has been tried out thoroughly by the author and by many of his colleagues; the result is a wholesale denunciation of it, bag and baggage, as it were. True, a modification of the pie winding is seen in many of the designs presented in this book but the pertinent fact is that the directions *do not* call for an annulus of wire, held together by wax, and with the turns laid on any-which-way. The sections may be thick or thin, but however they may be, they should be wound in even layers with a layer of insulating paper between layers of wire. This rule is invariably followed throughout in the description of the windings.

Enameled wire is favored in all secondary transformer windings. In the case of the induction coils, to be described, the wire may be cotton covered, as these windings are subjected to wax impregnation. The induction coil secondary is called upon to stand enormous potentials and it is subjected to but little heat. The transformer secondary, on the other hand, may become quite warm in operation and it should therefore be constructed to withstand this rise in temperature without deterioration. In this case, the enameled wire is excellent for it is impervious to moderate degrees of heat.

Transformer Design.—The questions: "How many turns of wire do I use in the primary?" and "What size should the core be?" are familiar ones in the files of the author. The computation is simple and it does not involve any great knowledge of mathematics for its working-out.

There are just a few basic principles to bear in mind before starting the calculation. The first determination is, of course, the capacity of the finished instrument. As the $\frac{1}{2}$ k.w. size is a popular one, this size has been selected for the example. As the transformer is to be used for

charging condensers, a large magnetic leakage is desired and this governs the shape of the core and the method of placing the windings. High efficiency is obtained only at correspondingly high cost and great weight of materials. In the present discussion of transformer design, the various computations have been reduced to the very simplest form possible in order that the scheme may be within the reach of any amateur worker who knows how to use simple arithmetic. The subject of copper losses has been neglected solely because it introduces one more calculation that has no practical bearing upon the net results obtained.

Let us assume, arbitrarily, that we wish a transformer of an efficiency approximating 93 per cent. Incidentally, the transformer designed in this chapter is the one employed in the later chapter on experimental high frequency apparatus. We wish a secondary potential of 5,000 volts; a primary wound for 110-volt supply; and we wish to operate the instrument on a 60-cycle circuit. If we wish an output of $\frac{1}{2}$ k.w. or 500 watts, and the efficiency is to be 93 per cent., it is obvious that we must have a greater input than 500 watts in order to compensate for the 7 per cent. loss.

The input is calculated by dividing the output by the per cent. efficiency; thus:

$$\frac{500}{.93} = 537.6344 +$$

or we must have an input of 537.6344 watts in order to take out 500 watts.

Core Volume.—The volume of the core receives our attention next. The initial step is to determine the watts loss in total and by subtracting 500 from 537.6344, or output from input, we find that the loss in the transformer is 37.6344 watts. This loss is made up of the I^2R losses which are due to the heating effects in the copper of the windings.

and the hysteresis and eddy current losses in the core; the latter are known as the core losses. The core losses constitute about 47 per cent. of the total of 37,634 watts, or 17,688 watts. Approximately 20 per cent. of the total core loss will be the eddy current loss and the balance of 80 per cent. must, therefore, constitute the hysteresis loss. To determine the latter loss in our core, we taken 80 per cent. of the core loss of 17,688 which gives us 14,150.4 for the watts lost through hysteresis.

Various Frequencies.—For practical purposes of the worker who builds the apparatus described in this book, the change in design necessary to adapt the various transformers for use on the various frequencies in commercial use, may be simplified so that when the design has been worked out for the 60 cycle instrument, the windings for 25 or 125 cycles become a simple matter of proportion. The cores may remain the same for all frequencies. Taking 60 cycles as the standard, the winding for 125 cycles may have just one-half the number of turns. The 25 cycle winding will have twice as many turns as the 60 cycle. In order to provide space for the additional turns of the 25 cycle winding, a wire one or two sizes smaller may have to be used but this is permissible in view of the intermittent work of the instrument.

Proportions of Core.—The proportions of the core call for some plain common sense and rule-of-thumb calculation. One thing to bear in mind is that the core must not be made too long and slim as the reluctance is then too great and the primary and, consequently, the secondary will have an inordinate number of turns with relatively high copper cost. On the other hand, to make the core too short and thick renders the winding difficult of insulation and the coupling too close. Experience only can demonstrate the happy medium at first trial. The diagram

given in Chapter IX shows a core of good proportions for this type of transformer and it may well be used as a pattern for instruments of larger or smaller size.

Let us take the cross-section of the core at 2 inches square for a trial. We must have at least 94.33 cu. in. of iron in all. If we make the rectangle of the core $9\frac{3}{4}$ in. long and $6\frac{3}{4}$ in. wide, outside dimensions, we shall have $9\frac{3}{4} + 9\frac{3}{4} + 2\frac{3}{4} + 2\frac{3}{4}$ or 25 inches of core leg. The section is 2 times 2 or 4 square inches. The length, 25, multiplied by the section, 4, gives us 100 cubic inches for the volume of this core. As it is always well to err on the right side, this core may be taken as quite satisfactory. The computations for the windings which follow will show that its proportions are just right. To determine the weight of the core we multiply its volume, 100 cu. in. by .25, as each cubic inch of laminated silicon steel weighs approximately $\frac{1}{4}$ lb. This gives us 25 pounds as the weight of the iron in the core.

We may next figure the current in the secondary winding at full load. As the potential is to be 5,000 volts, and the output 500 watts, we may divide secondary watts by secondary volts to find secondary amperes, which in this case will, of course, be .1 ampere. In power transformer work it is customary to allow at least 1000 circular mils of area in the conductor for each ampere of current to be carried. For our purposes, however, the transformer is to be used but a short time when it is permitted to cool and in practice a density of 600 circular mils per ampere has been found quite satisfactory and safe.

As the secondary current is .1 ampere, we find that our secondary conductor must have a area of 600 times .1 or 60 circular mils in order that it may safely carry the current. In the back of the book, we find tables giving the area of copper wires in circular mils No. 32 is found to

have an area of 63.21 and this wire is accordingly quite suitable.

The primary current is next in order. At a unity power factor, the primary watts divided by primary volts gives primary amperes. This we find to be $537.63 \div 110$, or 4.88 amperes. As the power factor of this type of transformer may be assumed to be in the vicinity of 85 per cent., we shall have to compensate for this by using a somewhat larger current value in the primary. Taking the apparent amperes as 4.88, we may multiply by 1.15 (assuming a power factor of 85 per cent.) and we get 5.61, or 5.61 actual amperes in the primary winding. Allowing here, also, 600 circular mils, we find that the primary conductor must have an area of 600 times 5.61 or 3366 circular mils. The wire table tells us that No. 15 has an area of 3,257 while No. 14 has an area of 4,107 circular mils. Following the rule of plenty, we may adopt the latter as the correct conductor to use for the primary.

We now come to the point that has puzzled more amateur experimenters than almost any other, *i. e.*, the calculation of primary turns. Of course, once this number is known, the determination of the secondary turns is a simple matter. The formula for the primary is not complex, and its working requires only the application of ordinary arithmetic.

The maximum flux is equal to the density multiplied by the area of the core in square inches. The e.m.f. generated in the primary winding is:

$$E_p = \frac{4.44 N T_p n}{10^8} \text{ where}$$

N —maximum flux,
 T_p —primary turns,
 n —frequency.

E_p —impressed primary voltage, therefore
 Primary voltage $\times 10^6$

$$T_p = \frac{\text{Primary voltage} \times 10^6}{4.44 \times N \times n}$$

Working this formula, we first determine the maximum flux. As the section of the core is 2 inches, we square this to get the area, or 4 inches. Multiplying the area by the density per square inch, we find that 4 times 30,000 will give us 120,000 for the maximum flux, N . The primary voltage is assumed to be 110 and the equation therefore becomes:

$$\frac{110 \times 100,000,000}{4.44 \times 120,000 \times 60} = 363 + \text{turns in the primary.}$$

As the turns in the secondary are found by the following formula, this calculation becomes simple:

$$T_p \times \frac{E_s}{E_p} \text{ where}$$

E_s represents secondary voltage, and E_p the primary voltage.

The secondary turns, assuming a secondary potential of 5,000, are as follows:

$$363 \times \frac{5,000}{110} = 16,480 \text{ turns in secondary.}$$

The space on the core for the primary and secondary winding is $2\frac{1}{4}$ in. long. Reference to the table of cotton covered wire shows that No. 14 D.C.C. wire winds about 13 turns per inch. As some space is quite essential between winding and core, let us make the primary winding $2\frac{1}{4}$ in. wide which will leave a space of $\frac{1}{4}$ in. on either side. In $2\frac{1}{4}$ in. we can wind 30 turns of the primary wire and, accordingly, we shall require 12 layers in order that the re-

quired 360-odd turns may be placed. Wound with a few thicknesses of oiled paper between layers of wire, the thickness of the primary winding from inside to outside of the coil or solenoid will be rather more than one inch.

If the transformer is to be operated on 70 volts, as from a rotary converter, the primary will contain 70/110 as many turns of wire. Working this we find that the proper number is 231 turns. For convenience, the primary may be made with the full quota of turns for 110 volts, with a tap at the 231st turn for the 70-volt connection. Likewise, for 220 volts, the number of turns would have to be doubled and in this case the wire would need to have but half the area. This would be No. 17 wire which has an area of 2,048 circular mils. For a maximum of convenience and adaptability with a minimum of complication, the winding may be of 363 turns of No. 14 wire, tapped at 231 turns, and then upon the No. 14 wire will be placed an additional winding of 363 turns of No. — wire with its starting end joined to the finishing end of the first winding. This primary permits the transformer to be used on 70, 110, and 220 volts without any change other than a simple connection.

The secondary turns we know to be 16,480. No. 32 enameled wire is suitable for this winding and this wire winds 112 turns per inch. Suppose we make each layer of secondary wire contain 230 turns; this will bring the width just over 2 inches which allows a good space for insulation from the core. Seventy-two layers of wire will give us 16,560 turns which is near enough to the stipulated 16,480. Perhaps for the sake of having finishing and starting turns come on opposite sides of the winding, it may be well to wind but 71 layers which will give 16,230 turns. This procedure is allowable and, indeed, preferable, as the difference

of a hundred-odd turns in the secondary will have no appreciable effect upon results.

The calculations for the weight of primary and secondary wire are obvious. If the coils are wound upon round forms, as they may well be, the average length of turn is easily determined and multiplied by the total number of turns. This reduced from inches to feet gives, on comparison with the wire tables, the weight of the wire in pounds.

Induction Coils.—In places where the 110-volt lighting current is not available, a battery of generous proportions may be made to produce a high frequency current through the medium of an induction coil in place of the alternating current transformer. The coil for this work should be constructed expressly for the purpose of charging condensers and its design is radically different from that of the conventional coil built to produce a long and stringy spark.

While almost any coil will give some results, the greater effects will be shown with a coil having a comparatively short and thick core and a secondary winding of rather coarse wire, as secondaries go. The secondary should be bunched near the center of the core rather than spread out over the entire length. The primary should be wound, preferably, with two small wires in parallel rather than with one large wire. This method permits of a closer winding and the inside diameter of the secondary may, accordingly, be made smaller.

The secondary coils should be layer wound and not pie wound. In a large coil, from four to eight sections of layer-wound coils will give ample insulation as the potential is not nearly so high in this type of coil as is the case with the type built for X-Ray work. The individual sections may be impregnated with a mixture of equal parts of rosin and beeswax.

Induction Coil Design.—The design of the coil for con-

denser charging may be summed up in a few words. We cannot calculate the different parts so nicely as we did for the transformer and our design must of necessity be a product of the "rule-of-thumb" school; that is, for the practical purposes outlined in this book. The core should take a certain fixed proportion and this may be stated as follows: The length of the core to be not greater than eight times its diameter; that is, a core eight inches long would be one inch in diameter, and so on in proportion. The number of turns in primary and secondary are dependent upon the voltage at which the coil is to be operated, the speed of the interrupter, etc., and, as the specifications given in this book are culled from practical experience, it is useless to attempt an explanation of the process through which this data was obtained.

Kicking Coils.—The kicking coil is a simple solenoid of comparatively coarse wire enclosing a core of iron wires tightly packed. It is preferable to the induction coil, with its primary and secondary, for use on 110-volt direct current circuits where a transformer cannot be used.

The design here is also a matter of experimental work, and no attempt will be made to expound the theory. Complete specifications are given in succeeding chapters on the construction of the various outfits in which kicking coils are satisfactory.

CHAPTER IV.

THE OSCILLATION CONDENSER.

The function of the high potential condenser in a set of high frequency apparatus is to take the high tension current from the transformer or induction coil, store it up until the "condensed" energy reaches a certain critical value, and then discharge the current across a suitable spark gap, thereby setting up electrical oscillations which constitute what is called the high frequency current. In its simplest practical form, the condenser consists of two sheets of tinfoil separated by a sheet of paper. Such a condenser will have a certain electrostatic capacity designated by the word "microfarad" or fraction or multiple thereof. The single sheet of paper with its foil coatings will have a capacity of but a small fraction of a microfarad or mfd. as it is abbreviated. By placing sheets of paper and tinfoil alternately in a pile and connecting the alternate leads from the foil in multiple, a condenser of practically any desired capacity may be made, the capacity increasing in direct proportion to the number of little condensers connected in multiple. On the other hand, if we take two identical condensers and connect them in series, the pair will have but half the capacity of either unit.

High Potential Condensers.—If a high tension current were impressed upon the simple condenser just described, the paper insulator or "dielectric" would not stand the strain and the current would puncture the paper. There-

fore, in order that the high voltage current may be used to store a large amount of energy in a condenser, the dielectric must be made of some material possessed of exceptionally good insulating qualities. Glass and mica are perhaps the best adapted to the purpose of the amateur builder. An air condenser is good as is also a condenser the plates of which are held in a tank of oil; these latter types are difficult and expensive to build, however, and they are, moreover, very cumbersome and heavy.

For permanent installations, where the apparatus need not be moved about, a modification of the latter type is excellent. By building first an ordinary glass plate con-

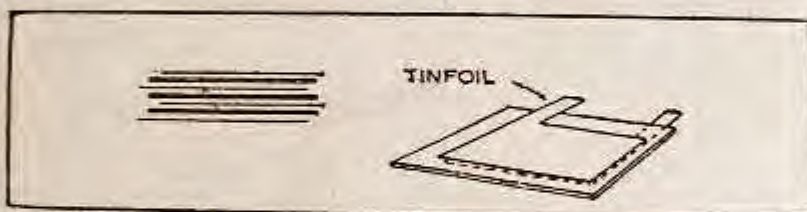

Fig. 11.—Single plate of glass coated on both sides with tin foil

denser and then immersing it bodily into a tank of oil, all brush discharges, which represent leakage and waste, are eliminated.

For most purposes of the amateur or experimenter, however, the simple glass plate condenser is quite satisfactory. Old photographic negatives of the 8 by 10 in. size may be had for the asking in many professional photographers' establishments. This glass is of the finest quality available in the open market, and it is certainly to be preferred to the ordinary window glass that is frequently used for that purpose.

If the 8 x 10 negative glasses are coated on both sides with tin foil cut into 6 x 8 in. pieces, each plate or separate

condenser will have a capacity of approximately .001 mfd. These plates may conveniently be grouped up into units of ten plates each, each unit therefore having a capacity of .01 mfd. By assembling any desired number of units into a suitable case or rack, the correct capacity for the apparatus under construction will easily be provided.

The tinfoil plates may be secured to the glass by means of quick-drying gold size, which is a varnish, or the foil may be applied after the glass has been given a very thin coat of beeswax applied when the glass has been heated gently over a flame or in an oven. In either event, it is well to apply the foil in a slightly larger size and trim afterwards. As the foil comes in sheets $6\frac{1}{2} \times 8\frac{1}{2}$ in. this is easily done.

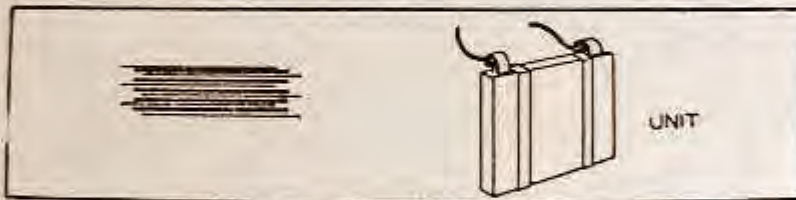

Fig. 12.—Ten plates of glass built up into a unit with alternate lugs connected in multiple

When the foil has been secured on both sides of each piece of glass, the units may be assembled with strips of thin copper ribbon placed alternately projecting to right and left between the plates of the unit. These lugs, of course, provide the means of connection. The unit is then bound with linotape at top and bottom, the lugs folded around lengths of flexible lamp cord and soldered, and the entire unit immersed for two hours in a molten compound of equal parts of beeswax and rosin. When this mixture cools, it will form a solid, non-hygroscopic seal for the unit of the condenser, preventing brush leakage, and excluding

moisture. This procedure is to be followed in the construction of every condenser described in this work with the exceptions specifically noted.

Mica Condensers.—The use of mica as the dielectric for the condensers of portable high frequency apparatus cannot be too strongly recommended. The material is light in weight and it is possessed of electrical properties that render it admirably adapted to the purpose. Electrical mica is costly, however, and as the size of the sheets increase, the cost goes up in proportion; but the price is not prohibitive if light-weight is an important consideration. The mica may be obtained in small sheets of almost any desired thickness. The method of assembly is identical with that of glass.

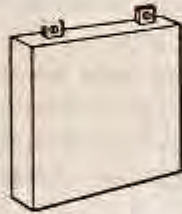

Fig. 13.—One section of moulded condenser.

Moulded Condensers.—This type of condenser is not within the reach of the amateur constructor's shop equipment as its manufacture requires the use of very expensive dies and presses capable of exerting enormous pressure. The moulded condenser may be purchased outright, however, in sections having a capacity of .002 mfd. each.

The moulded condenser is mechanically strong—indeed, it is practically unbreakable. The conducting material is of copper in sheets approximately five inches square and these sheets are completely sealed into a solid block of hard, waterproof, and practically heatproof composition.

that forms also the dielectric between the plates. Such a condenser is ideal for the portable outfit for use on the stage or where great ruggedness is essential. Each section weighs approximately 2 lbs. and an entire condenser of .02 mfd. capacity would weigh but a fraction over 20 lbs. The outside dimensions of each unit are $6\frac{1}{2} \times 6\frac{1}{2}$ in. while the thickness is about $1\frac{1}{8}$ in.

CHAPTER V.

THE SPARK GAP.

The function of the spark gap is to provide a gap between suitable metal electrodes for the high potential current stored up in the condenser to leap across, thereby setting up the electrical oscillations. The gap, in its simplest form, is a pair of zinc cylinders placed end to end and insulated from each other; a means is provided whereby the distance between the electrodes may be adjusted to the necessary point. This adjustment may be provided conveniently by threading the rods of zinc and supporting them in standards in which tapped holes have been prepared. A large knob or disc of fibre on one electrode enables the operator to make the adjustment while the current is passing.

This simple gap is open to many objections when the higher powers are encountered, although it is quite satisfactory for use with the induction coil sets or small transformer outfits. On transformers $\frac{1}{2}$ k.w. or over, the simple gap quickly becomes heated to excess and the operation is unsatisfactory. An improvement is afforded by placing radiators on the electrodes to aid in the dissipation of the heat as it is formed. A further improvement is the use of larger electrodes of zinc and a step still further is taken if the electrodes are made of nickel-steel; owing to the difficulty of work this substance, however, it is not considered within the reach of the experimenter. It is

sometimes possible to obtain the nickel-steel rod in suitable lengths, however, and, in this event, it should most certainly be employed.

If an air blast is directed against the electrodes and into the gap, the operation will be improved materially. The current of air serves not only to cool the electrodes but to wipe out any arc that may tend to form.

The Rotary Gap.—In this type of gap, one electrode is stationary while the other rotates past it a certain number of times per second. The various modifications of this simple rotary gap are bewildering to contemplate and no attempt will be made to describe all of them. Suffice it to say that the rotating member may consist of a single



Fig. 14.—Designs of stationary spark gaps. The type at the right is fitted with rotating discs to dissipate the heat generated by the spark

disc of metal from the periphery of which pieces have been cut to form teeth; or it may be a disc of metal with metallic studs fastened to it to form the rotating electrodes; or it may be a disc of insulating material with metal studs passing entirely through it near the periphery; in the last instance, the stationary electrode will be in duplicate, with one on either side of the revolving disc.

The advantages of the many types are mechanical rather than electrical. The builder, in selecting a certain type, will have to consider the limitations of his shop equipment. One is about as good as the other so far as results are concerned, and almost any rotary gap is better than even a good one of the stationary form.

The number of studs or sparking points required will depend upon the diameter of the rotor disc and the speed at which it is to be driven. The number of studs and the speed govern the tone or pitch of the note imparted to the spark. With 12 points and a motor running at 1,800 R.P.M. the tone of the spark is musical and pleasant to the ear; this is in striking contrast to the crackling or crashing spark of the stationary gap. While this feature is of greater importance in the case of radio telegraph apparatus than with demonstration coils, still the pleasing musical note makes a good impression upon the audience.

The distance between the rotating and the stationary

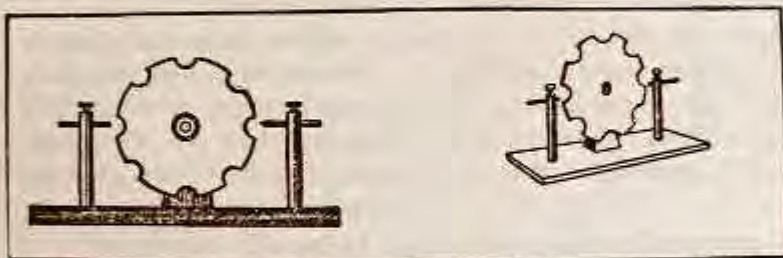

Fig. 15.—Simple rotary gap

electrode should, in general, be as short as possible without striking. The gap should certainly be adjustable by small degrees and the adjusting mechanism should preferably employ a screw with an insulated knob in order that the spark gap may be varied while the current is passing.

The Quenched Gap.—By making the spark gap electrodes very massive, facing them off very accurately in a lathe, providing large radiation surface on each electrode, and, finally, by supporting the electrodes in such manner that the separation of their faces is but a few thousandths or perhaps hundredths of an inch, we have what is commonly termed the quenched gap. The large mass of metal

and its radiation surface tends to dissipate the heat as fast as it is produced and the condenser discharge takes the form of a series of very short, clean, and nearly undamped surges. The large surface and the short gap increase the total number of discharges per alternation of the current from one or two per alternation to several hundred or perhaps a thousand. This does not mean that the frequency of the current is affected by the quenched gap characteristics just mentioned. The frequency of the oscillations may be just as high in the ordinary gap but the groups or trains of oscillations, or perhaps we had better say the

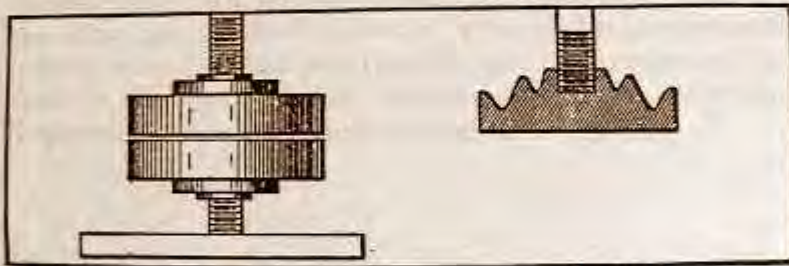

Fig. 16.—Simple form of quenched gap

groups of condenser discharges, may occur many more times per second, or per alternation of the current, in the quenched gap. That is to say, the condenser becomes charged and discharged many more times per second, while the frequency of the oscillations in each separate discharge may remain fixed.

The advantages of the quenched gap are manifold while the difficulties identified with its construction and use are almost as numerous. The quenched gap requires good tools and good workmanship. In operations, it is likely to become overheated and its operation will then be un-

steady. It is heavy as compared with the ordinary gap and it is costly.

To counterbalance the disadvantages enumerated, we may say that the results obtained from this form of gap are remarkable. The high frequency discharge from a Tesla or Oudin coil operated with it is astonishing; instead of the thin, wiry discharge or spark, we get a flaming, white discharge that can best be compared with the flame from a very high potential, low frequency transformer. The high frequency discharge is not silent, however, but it partakes of a loud, crashing hiss. For electro-therapeutic work, the quenched gap is splendid, providing it is properly designed, built, and cared for. The X-Ray current is particularly energetic and for auto-condensation, where a high discharge rate is imperative, the milli-amperage may reach 1400 without great discomfort to the patient. So, the reader will see that even with all of its many troublesome features, the quenched gap is well worth building, if for purposes of experiment only.

The Rotary Quenched Gap.—For radio telegraphy, a high pitched note is highly desirable as this spark can be distinguished from the atmospheric crashes and other extraneous sounds so often heard in the telephones of a radio receiver. The ordinary rotary gap gives this note and works well. The 500-cycle alternating current sent into a special transformer and used to discharge across a quenched gap works even better but the 500-cycle current is a thing not to be attained by the average experimenter. Along came a chap a few years ago with a combination of quenched and rotary gap that threatened to displace the 500-cycle sets for, by means of his transmitter, the ordinary 60-cycle current could be sent into the apparatus and be made to produce a clear-cut musical note

with every possible advantage of the quenched gap and with many additional advantages as well.

In the rotary quenched gap, the rotating electrode takes the form of a large copper disc having radial slots milled across its surface and thus leaving wedge-shaped members of copper protruding for the sparking surface. The stationary electrodes were two in number, each forming a semi-circular piece of copper with radial slots and projections to correspond with the rotary member. The latter was placed upon a shaft and mounted in suitable bearings so that it could be held with its face but a few thousandths of an inch from the stationary members, and rotated at a high rate of speed. Here we have the true quenched gap, subdivided into a series of discharge points which, when the disc was rotated, split the condenser discharges into groups which were clearly defined and which imparted the beautiful musical tone to the spark.

CHAPTER VI.

OSCILLATION TRANSFORMERS.

The function of the oscillation transformer is to take the oscillatory current set up by the discharge of the condenser across the spark gap, and increase it from a potential of a few thousand volts to practically any desired potential. While the principle is exactly the same as that involved in the ordinary low frequency transformer, the high frequency type is possessed of a few characteristics peculiarly its own. For instance, the primary winding of the oscillation transformer may have from one to ten turns of very thick copper conductor in it; in this short and very low resistance winding, current oscillates at a potential of several thousand volts. The secondary of the oscillation transformer may contain but a single layer of wire, with a total number of turns running into hundreds instead of thousands or tens of thousands as is the case with the low frequency type; but in this short secondary, with its few turns, may be induced an immeasurably great potential—a voltage running into the millions. The third, and perhaps the greatest, distinguishing feature of the oscillation transformer is the fact that it has no iron core; the presence of any iron whatever is detrimental to the action of the device.

Various Types.—Considerations of voltage, current, weight, frequency, and the various factors of this nature enter into the design of the oscillation transformer. The windings may be insulated by air space, oil, wax, or pe-

trolatum. The primary may be an open helix of bare copper bar, strip, ribbon, or tubing, or it may consist of a coil of heavily insulated cable. The secondary may be wound in a single layer upon a cardboard or wooden cylinder, or upon a wooden cage, or it may be wound in a series of narrow layers on insulating paper or cloth. The secondary may also be in the shape of a cone or a flat spiral resembling a spider web.

Oudin and Tesla Types.—Oscillation transformers may be broadly classed under these two headings. The Oudin

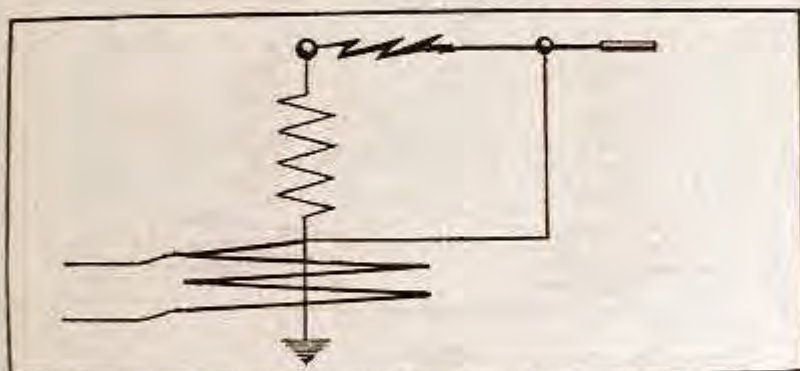

Fig. 17.—Wiring diagram for Oudin coil

coil is in reality an auto transformer, *i. e.*, its primary and secondary are connected together at a neutral point which, in the case of high frequency apparatus, should be grounded. In the Tesla coil, the only connection between the primary and the secondary is an inductive one; the two windings are separate and distinct. (See Fig. 18.)

The third type that should be mentioned, as it is perhaps the most practical of all, is a combination of the Tesla and Oudin circuits. This consists of two Oudin resonators placed side by side and having their ground connections

joined with a cable which places the two primaries in series. The oscillation circuit is, of course, through both primaries. Still a further modification of this circuit is made by placing the two resonators base to base as shown in Fig. 20. This makes virtually a Tesla coil of the pair, the only distinction being in the grounded neutral point.

Advantages of Various Types.—The Tesla coil gives the longest spark between points of any of the various types. This coil is difficult of construction, however, and in mechanical design it is fundamentally poor. The greatest

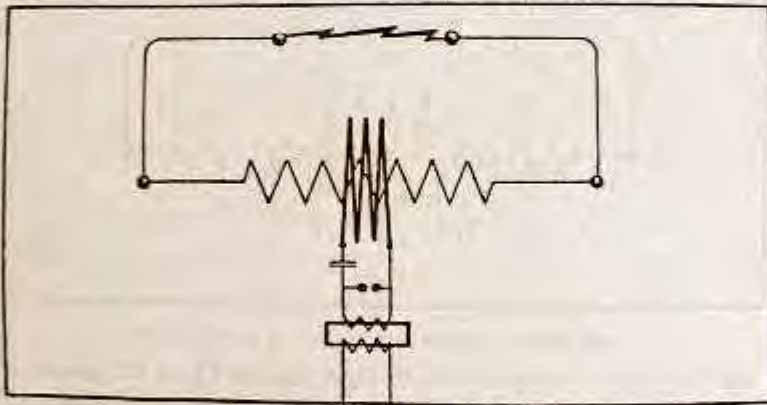

Fig. 18.—Wiring diagram for Tesla coil showing transformer, spark gap and condenser

problem is to support the primary and secondary and still prevent leakage of the current. The combined type, Fig. 20, or the style shown in Fig. 19, will overcome this difficulty with but a slight loss in results obtained.

The Oudin coil gives an enormous brush discharge from its single terminal. In a large coil, the streamers of purplish fire dart out like the branches of a tree to a distance of several feet in all directions. Such a coil, properly proportioned and carefully built will give splendid results.

The construction is simple and the design strong both electrically and mechanically. For portable purposes, the Oudin coil is the ideal type to use, particularly if it is desired to keep down weight and bulk and to have apparatus that will stand the hard knocks of road work.

Proportions of Coils.—In the actual construction and subsequent use of some dozens of different types of high frequency coils, the author has evolved a few simple rules, which, for some inexplicable reason, appear to give the

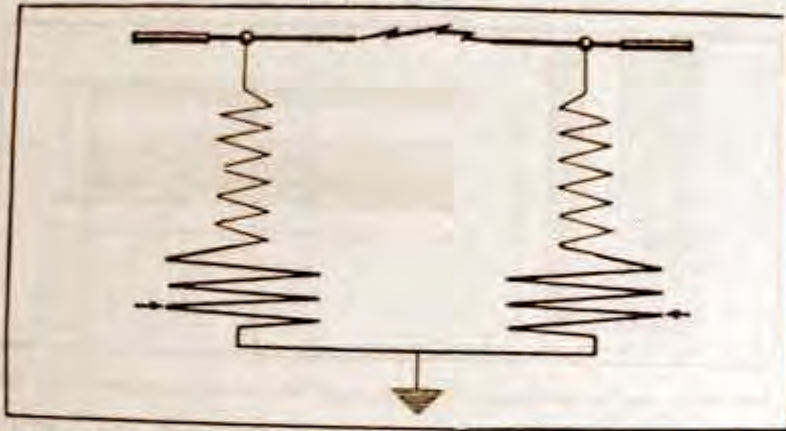

Fig. 19.—Two Oudin resonators placed side by side to produce very long sparks

pass-word to the realm of successful coil building. While there is a perfectly good method by means of which these coils may be designed "on paper," through the medium of various formulæ, all more or less complex, the average practical worker in this field will admit that the time-worn "rule of thumb" method is possessed of certain advantages in this case as in others, particularly when the results of "rule of thumb" calculation are carefully noted and the mediocre designs eliminated from future consideration.

With this brief explanation or, perhaps, apology, for

the use of the much used—and abused—rule of thumb, we may proceed to look into the actual design of oscillation transformers of various sizes and for various purposes. Without attempting any explanation of the reasons therefor, the author may state that, in his experience, the secondary of the Tesla coil should be wound upon a cylinder the length of which is three times its diameter. The Oudin resonator secondary should be wound upon a cylinder having a length slightly less than twice its diameter. Applying this simple rule, a Tesla coil with a secondary 12 in. in diameter, would be 36 in. long. The Oudin coil would

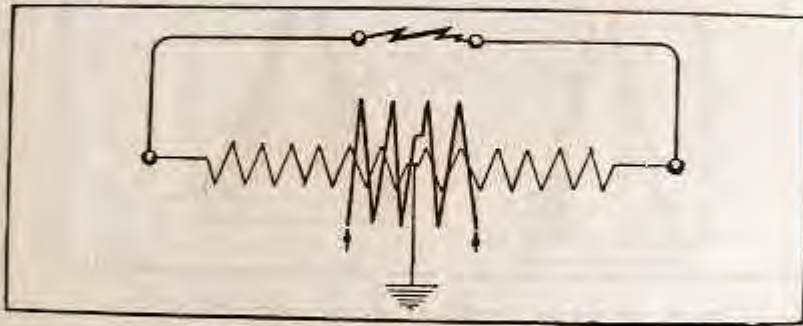

Fig. 20.—Two Oudin resonators placed base to base

be about 22 to 24 inches high if its diameter were 12 ins. This rule applies only in the case of truly cylindrical secondaries.

The number of turns of wire on cylindrical Tesla coil secondaries should be in the proximity of 800, while the Oudin secondaries may contain from 400 to 600 turns for long sparks and from 100 to 300 for shorter and heavier discharges. This rule has been found to follow in the case of either large or small coils and the figures given have been taken from charts giving the effective windings for a great many coils.

The cone-shaped coils are particularly effective as they are theoretically correct in design. The proportions for cones may vary from a perpendicular equal to the diameter of base to a perpendicular 1.5 times diameter of base. The latter is better for long sparks. The windings of cones should contain from 100 to 500 turns of wire for short and thick, or long and comparatively thin sparks, respectively.

For the very closely coupled coils such as the pancake form, where the winding is in layers, and the coil sealed in, the number of turns may run up as high as 1500 to 2000

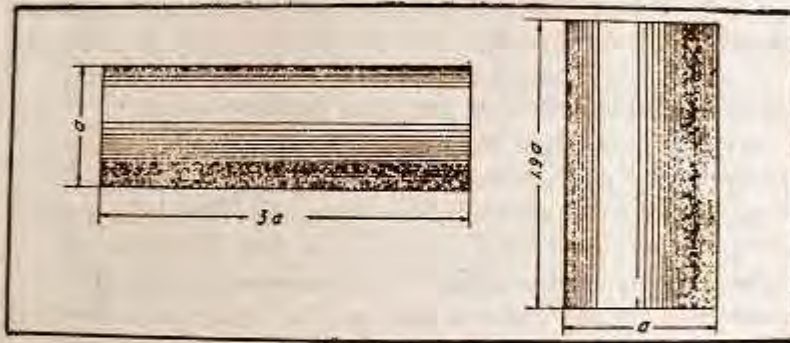

Fig. 21.—Showing proportions for Tesla and Oudin secondaries of any desired size turns. The coil is of comparatively small diameter in this event. The layers of wire should never be very wide as the insulation will not hold up.

The conductor for the secondary windings of all types of oscillation transformers should be of soft, pure copper wire. The insulation may be of cotton or silk but *not* of enamel. The use of the latter for high frequency secondaries has given the author great disappointment in the construction of several large and comparatively expensive coils. The insulation on the wire is of no value whatever except to provide a mechanical separation for the turns

of wire and to form a base or support for whatever insulating substance is applied to the wire subsequently.

Secondary Insulation.—One fact stands out prominently after the worker has built and experimented with a few coils. No solid insulation of any kind is of the slightest avail when working with high frequencies and very high potentials; glass, hard rubber, mica, empire cloth, and even paraffin wax seem actually to help the current to pass. The terminals of a coil may be separated beyond sparking distance in air and when a piece of heavy plate glass is

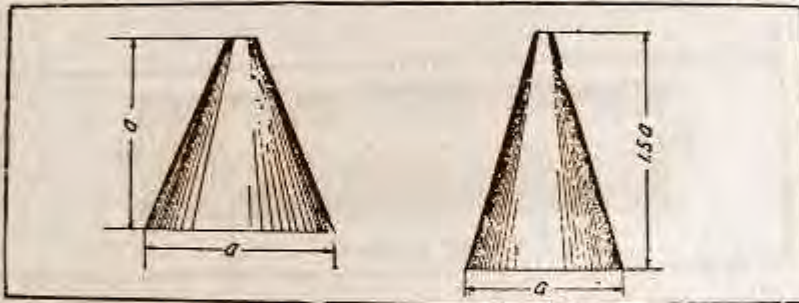

Fig. 22.—Proportions for cone-shaped secondaries of any size

interposed, the discharge immediately starts to wind its way over the surface of the glass, finally piercing the plate as if it were of cardboard. Therefore, let the uninitiated worker bear this fact in mind: That to attempt the insulation of the Tesla primary from the secondary by means of any of the old reliables in the case of the ordinary induction coil, is the height of folly in the case of the high frequency coil. Liquid oil, freed from all moisture, is the very best insulator for these high frequency currents. It is heavy and sloppy to handle, however, and its use precludes the possibility of obtaining the beautiful brush ef-

fects from the secondary in the air. Next to oil comes a mixture of beeswax and rosin in equal parts. This seems to be practically the only solid, or nearly solid, insulating substance that will stand up under the strain. Last of all comes air. We say last because the air insulation must be greater in extent than either of the predecessors; but notwithstanding this fact, the air insulation is the one cheap, light-weight, and absolutely reliable insulation that the high frequency worker has at his command. A separation of a few inches more, perhaps, between primary and secondary, but a mechanically and electrically good construction, and, what is more, accessibility of all of the parts at an instant's notice, is the significant list of advantages possessed by this insulating medium.

On air-insulated coils, the secondaries should be wound with a space between each turn and its neighbors. This space will depend upon the potential to be set up at the top of the coil and ordinarily the separation should be about the width of the wire itself. Bare wire may be used but it is not recommended. Double cotton covered wire has been the choice of the author after many experiments to determine the relative merits of all known coverings. The double cotton covering forms an excellent base to soak up shellac which, when applied in a half-a-dozen coats, and thoroughly dried out, has been found to seal up the turns on the open cylinder, preventing in large measure, the leakage between the turns when the coil is operating at full power. Theoretically the winding of the secondary should start with turns close together at the base, the separation gradually widening out as the top or high potential end of the coil is reached. This method of winding is impracticable for the average amateur constructor, however, and he must needs resort to the next best expedient of making all turns sufficiently separated to take care of the potential.

Oil and Wax Insulations.—The oil insulated coil may be very closely coupled; that is, the primary may be but slightly separated from the secondary. The case or container for the coils may be of wood, lined with zinc. The cover, of course, must be of some good insulating material such as glass, hard rubber or marble. Slate should not be used as the minute metallic veins found in some varieties will be ruinous to the output of the coil. The high potential leads from both primary and secondary may be brought up through porcelain, glass, or hard rubber insulators attached to the top of the case and extending down into the oil.

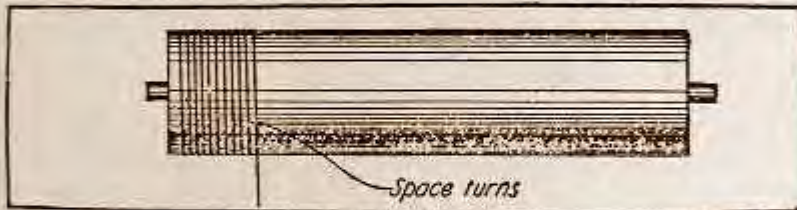

Fig. 23.—The turns of wire in the secondary should be spaced to provide adequate insulation for the extremely high potential

The compound of equal parts of beeswax and rosin previously mentioned is used to seal in the pancake coils of portable electro-therapeutic outfits where every effort must be expended in the direction of light weight and compactness. This compound is melted up in a double boiler, as the insulating properties are ruined if the mixture is permitted to scorch. The pancake coil, which is specifically described later in this book, is immersed in the hot compound and permitted to remain for hours until the windings and the paper separating layers are thoroughly impregnated with the molten wax.

The advantages of the close coupling of primary and

secondary made possible through the use of some better insulator than air are found in the greater efficiency of the oscillation transformer constructed in this way. The spark is thicker and hotter, as well as being of the desired length. This quality is to be desired in X-Ray work in particular. For demonstration apparatus, however, the builder can do no better than use the air insulated coils.

Constructional Features.—The simplest Tesla or Oudin coil to make is that in which the secondary is a cylinder of cardboard such as a large mailing tube, or a tuning coil cylinder, wound with a few hundred turns of insulated magnet wire. The primary may consist of a few turns of copper ribbon wound into a spiral with the turns separated by a strip of corrugated board such as is used for packing purposes, the whole being secured with tape at four or five points on the spiral.

From this simple start, larger coils may be developed along similar lines. Cardboard cylinders may be purchased in sizes as large as 8 x 13 in. and larger ones may be made to order. Very large cylinders should be made of wooden slats pegged with wooden pegs to wooden discs of the desired diameter.

Primaries may be of almost any heavy conductor available. As the tendency of the high frequency current is to travel upon the surface of the conductor, it is highly desirable that the primary be made either of flat ribbon or strip copper, or else of copper tubing of relatively large diameter. Stranded conductor is excellent and if the precise number of turns is known and no tuning necessary, the builder may use heavy stranded cable with excellent results.

The ideal primary conductor is copper strip or bar, wound edgewise into an open helix. Such a primary may be made compact and mechanically strong and it is splendid from the electrical standpoint. This conductor permits of

closer coupling without danger of sparking from secondary to primary. The edgewise wound strip is difficult to make as the reader may well imagine. The mechanical problem involved is a real one and for the few turns the average worker will require, to construct a winding rig would be out of the question. The strip can be purchased ready wound, however, in three convenient sizes, and its use is specified in the construction of several coils in this work.



CHAPTER VII.

INDUCTION COIL OUTFITS FOR BATTERY CURRENT

Of all the experimental apparatus within the reach of the amateur builder, none can compare with the high potential, high frequency transformer when it comes to a question of demonstration or entertainment. A simple card-board cylinder, wound with a few hundred turns of magnet wire in one layer, set on the top of the helix of his wireless set will give the experimenter a spark several inches long. This spark he can play with to his heart's content for it is perfectly harmless. Taken through a piece of metal held in the hand, the current produces no shock whatever even though the voltage may be expressed in the thousands. This is explained by the fact that the current changes its direction of flow so rapidly that the nerves cannot transmit the sensation of pain and the muscles cannot respond to the pulsations.

Induction Coil Apparatus.—The experimenter who numbers among his possessions a spark coil suitable for radio telegraphy, may delve into the mysteries of high potentials, and high frequencies without spending any great amount of money for the extra apparatus needed. If he has the coil, he will most likely have also a spark gap and a high tension condenser.

With this equipment to start off with, the experimenter will have only to add a simple Oudin resonator to his outfit in order that he may play with the sparks for the entertain-

ment of his friends and himself. The resonator can be built by any worker who has made a tuning coil. A cardboard cylinder from 2 to 4 in. in diameter and twice its diameter in length may be fitted with the usual wooden heads and given a coat of shellac. When the latter is quite dry, the cylinder may be mounted between centers in a simple winding rig such as is shown in the illustration. The cylinder, turned away from the operator by hand, is then to be wound full of double cotton covered wire which may be of any size between 34 and 28 B. & S. gauge.

The completed secondary is then to be coated with several applications of shellac, each layer being permitted

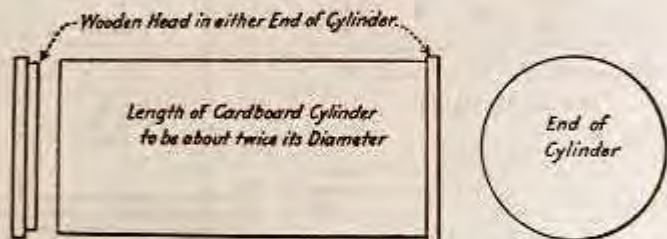

Fig. 24.—Cardboard cylinder and wooden heads for secondary of oscillation transformer

to dry thoroughly before the next is applied. When the final coat is hard, the secondary may be mounted upon a simple wooden base by means of screws passing up from beneath and into the lower wooden head. The lower end of the winding is carried down through the base to a terminal which will be "ground." The upper end of the winding terminates in a rod carrying a brass ball at its tip. This ball and rod may be taken from the clapper of an old electric bell, or, the ball may be a large leaden shot of the variety known as "buck shot."

The primary is composed of twelve turns of very heavy copper wire such as is used for the transmitting helix in a

wireless set. The wire is wound upon dowel rods set up in the base surrounding the secondary coil. The rods should be so placed that the inside diameter of the primary winding is $1\frac{1}{2}$ times the diameter of the secondary. The winding of heavy wire should cover $\frac{2}{3}$ of the height of the secondary cylinder. If the induction coil used to excite this oscillation transformer is of large size, the secondary may send sparks into the primary. In this case, the primary must be made larger in diameter. The directions here have been for a comparatively close-coupled coil as

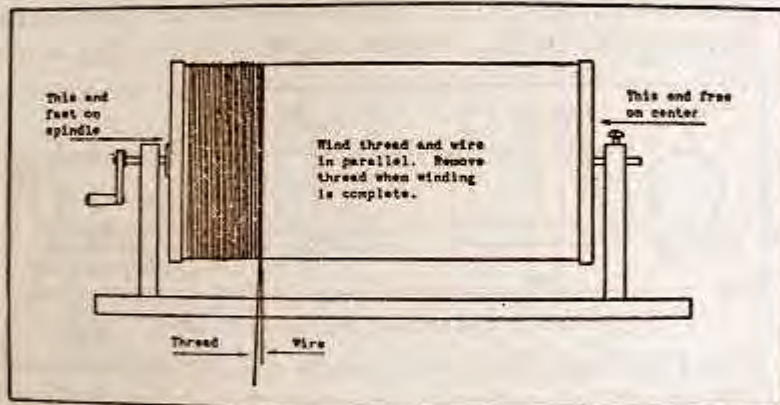
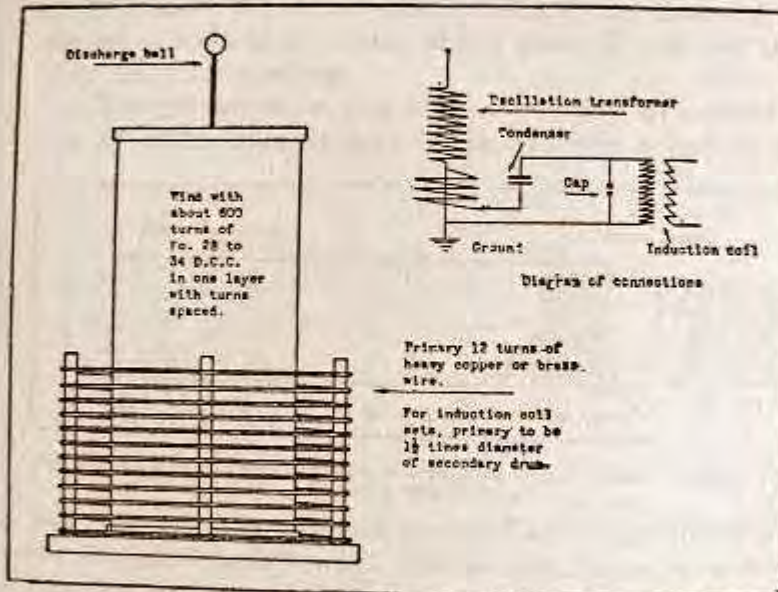

Fig. 25.—Apparatus for winding secondary of oscillation transformer

that type will give maximum results with the usual wireless spark coil.

The lowest turn of the primary helix is to be connected with the ground terminal to which the lower end of the secondary winding is attached. The wiring diagram is given in Fig. 27, and the reader will notice that the spark gap is connected across the secondary of the spark coil; the condenser and primary of the resonator are in series across the spark gap. When operating the coil, try various capacities of the condenser, a variation of the turns of the

primary, closing up or opening the spark gap, etc. A few trials will bring the circuits into resonance and the ball at the top of the resonator will give out beautiful streamers of purplish fire. If a piece of metal is held in the hand and approached to the ball, a spark several inches long will jump into the metal without the operator feeling the slightest sensation of shock.



Figs. 26 and 27.—Data for small Oudin resonator and diagram connections

Induction-Coil Construction.—In the event that the experimenter is not the possessor of an induction coil giving a fat, hot spark, he will need either to buy one outright or else construct one in his home workshop. The latter course is permissible if he is a fairly careful and patient mechanic.

The data given in this chapter is for the construction of a coil built expressly for radio and high frequency work

and it is totally different in windings and proportions from the ordinary spark coil that is intended primarily to give a long spark. The coil to be described is not rated in spark length but in watts capacity. Through the use of a suitable interrupter, this coil may be operated at 10 volts and 10 amperes continuously. The secondary winding is of comparatively low resistance, thus it is well adapted to the purpose of charging condensers.

Core and Primary.—The core of this coil is a bundle of soft iron wires tightly compressed into a cylinder 12 in. long and $1\frac{1}{2}$ in. in diameter. The core wire can be purchased ready cut and perfectly straight so that its formation into a cylinder is a simple matter. Given the necessary

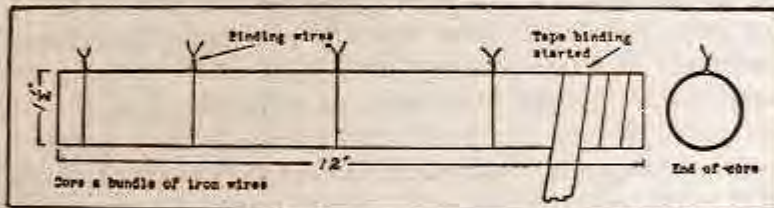

Fig. 28.—Core with tape binding started

amount of straight iron wires, the builder grasps the bundle. The silk is tough and strong and the worker will be enabled to preserve the solidity of his bundle as he removes the binding wire and replaces them with the silk wrapping. with both hands and with a twisting motion forms the wire into a compact cylinder. A piece of wire is then wound around the middle of the core and twisted. Another is added at each end. The twisting operation is then continued, taking up the slack in the binding wires by twisting the ends with a pair of pliers. Soon the bundle will be perfectly straight and hard.

Starting at one end, the binding wires may be removed and a winding of silk ribbon started spirally over the core.

When the entire core is covered, the final turn of ribbon may be held with shellac and a few turns of thread taken over the end to insure permanency. The whole core, with its wrapping of ribbon, is then to be suspended in a trough filled with thin shellac. A submersion of an hour will have served largely to fill the interstices between wires and to soak the ribbon thoroughly. The core is then hung up to drain and dry. The latter operation will take the best part of 24 hours. When the shellac is hard, the core will be almost as solid as if it were of one piece of iron, and it is then ready for winding.

The primary is in two layers. The end of a spool of No. 14 D.C.C. magnet wire is placed under a loop of the



Fig. 29.—Core and primary, showing how finishing end of primary winding is held under a loop of tape.

silk ribbon on the core and the winding started by turning the core with both hands. The second turn of wire grips the ribbon loop and thus secures the starting turn. The first turn should start at a distance of one inch from the end of the core and the first layer ends at this distance from the other end. The second layer of wire is wound upon the first, with a layer of empire cloth between. The finishing end of the primary winding is secured with a loop of ribbon, the ends of the loop being pulled tight after the ribbon has been covered by the last three or four turns of the winding. The entire primary is then to be wound with

silk ribbon in exactly the same manner as the core and the end where the leads come out should be wound with a number of turns of strong thread to prevent the possibility of the starting and finishing turns coming loose. The entire core and primary is now to be immersed in a compound of equal parts of beeswax and rosin, melted in a double boiler to prevent scorching. An immersion of an hour or two will suffice when the coil may be removed to drain and cool.

Insulation.—When the primary has cooled, it may be covered with four layers of micanite sheeting. This substance is built-up mica made into a flexible sheeting about $\frac{1}{16}$ in. thick. Very thick shellac is liberally applied as the wrapping proceeds and when the final turn of the micanite is taken over the primary, the whole cylinder should be temporarily wrapped with tape until the shellac dries out thoroughly. When this is at last accomplished, the structure is to be placed in an oven until slightly warm, after which it is stood on end with the lower opening filled and the beeswax-rosin compound poured into the space between primary and insulating tube. The length of the latter is 10 in. and an inch of core is therefore left projecting at either end to permit of mounting in the frame to be described.

Secondary Winding.—The secondary is wound in four sections, each section being wound in layers upon oiled paper $1\frac{1}{2}$ in. wide. The wire is No. 32 S.C.C. Each layer contains 112 turns of wire and the width of the layer of wire is 1 in.; therefore, there is a margin of $\frac{1}{4}$ in. on either side of the layer of wire. Each section is wound in 61 layers and the total turns to each section is accordingly 6832. The four sections will comprise 27,328 turns in consequence.

The secondary sections may be wound either in a lathe or else upon a form mounted in a simple winding rig such

as the illustration suggests. The outside diameter of the micanite insulating tube over the primary will be approximately $2\frac{1}{4}$ in. and this shall therefore be the internal diameter of the sections. The form consists of a disc of wood nailed to one end of a short cylinder of wood and the whole mounted either in the lathe or in bearing supports as shown. The cylinder should be $2\frac{1}{4}$ in. in diameter and about 2 in. long.

In starting the winding of a section, the wooden cylinder should be covered with a layer of cord to make possible

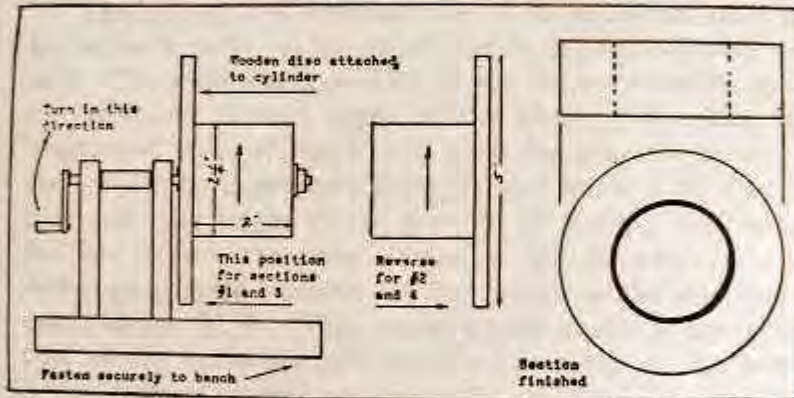

Fig. 30.—Winding apparatus for secondary sections

the removal of the section. The first layer of oiled paper may be wound upon the cord which is pulled out after the section is finished. In the first paper layer there should be six or eight thicknesses of the oiled paper to make a mechanically strong support for the winding. The starting end of the No. 32 S.C.C. wire is soldered to a piece of thin copper ribbon inserted between layers of paper, and the first layer of wire wound until 112 turns have been placed. At this juncture the winding should be an inch wide. A layer of oiled paper is then taken over the wire

and the second layer of winding placed. This is continued until 61 layers have been wound. The finishing turn of the wire is soldered to a piece of copper ribbon and ten layers of paper taken over the wire. The ribbon passes between the eighth and ninth layers of paper which hold it securely. This completes a section which is now to be impregnated with the beeswax-rosin compound.

In winding the first section, the builder is to turn the lathe away from him and have the disc-end of the cylinder at his left. The winding is to start at the left hand end of the cylinder next to the disc. This procedure is also to

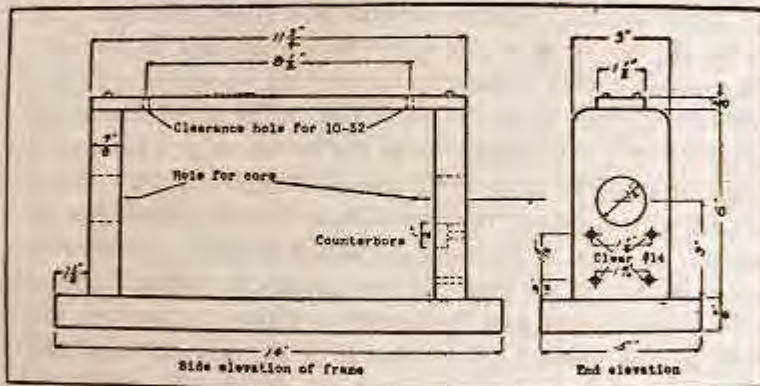

Fig. 31.—Details of the frame work

be followed with one more section. When these two sections are wound they should be numbered 1 and 3. The winding rig is then to be reversed so that the disc-end of the cylinder is at the right. Starting the winding next to the disc as before and turning in the same direction, *i. e.*, away from the operator, the section under construction will be wound in the opposite direction from the two predecessors. This section is to be numbered 2 and its companion, No. 4, is wound in the same way. The reason for this will be seen when the assembly starts.

Assembly.—The frame of the coil is well shown in Fig. 32. The ends of the core fit into holes into upright pieces of wood which form the supports for the entire coil. The secondary sections are arranged upon the micanite tube in the order of their numbers, starting from left to right. If the winding has been done as described, the first outside lead will go to the binding post, S^1 , the inside lead of section 1 to that of section 2; the outside lead of section 2 to the outside lead of section 3; the inside of 3 to the inside of 4; and the outside of 4 to the remaining binding post. The two primary leads are carried to one binding post in the base and to one side of the interrupter respectively.

Interrupter and Condenser.—An independent interrupter is much to be preferred for use in connection with this coil. The interrupter may be of the mercury-turbine type, the vibrating contact type, or the electrolytic. The last mentioned style of break will give the greatest results if the interrupter is properly designed and built; if the worker does not care to go to the trouble of making this rather delicate device, the construction of which involves some rather good glass-working, he may purchase the interrupter outright for \$2.25. This price would scarcely cover the cost of the materials and the workmanship on the break if the amateur worker were to build one.

The vibrating type of break will give good results if its contacts are of generous proportions and the component part of the interrupter properly designed. The data given herewith specifies the use of hard silver contacts $\frac{5}{16}$ in. in diameter rather than platinum ones of a much smaller size. Before we proceed with the description of the vibrating interrupter, however, a brief mention may be made of the mercury-turbine break, which is in many ways the ideal type.

In the mercury-turbine break, a stream of mercury is

raised through the medium of a pump and projected in a fine stream against a series of metallic vanes with which it makes successive contacts. This device is even more difficult of construction than any of the other types and no attempt will therefore be made to describe it in detail. The mercury-turbine interrupter costs in the proximity of \$9.00 and it requires a small electric motor for its operation. It may be used on practically any voltage from six to 110.

The relation of the vibrating interrupter to the rest of the coil is shown in Fig. 32, while the details of the interrupter are given in Fig. 10. Using the reference numbers in the drawing, 5 is a spring of phosphor bronze, $3\frac{1}{4}$ in. long, 1 in. wide and approximately $1/32$ in. thick. To the end of this spring is secured the armature, 6, of soft iron, by means of four small screws. This armature may be turned from $1/8$ in. soft iron bar or it may be cut from the end of a 1 in. rod of the same material. The contact, 7, is cut from a piece of $1/8$ in. silver rod, drilled and tapped for the small screw that secures it to the spring in the position shown. The stationary contact, 8, is made of the same material and it is carried on the end of the 14-20 milled-head screw, 9, which is threaded into the stud of silver. The adjusting screw, 9, is carried by a cross arm of heavy brass bar, 10, which, in turn, is supported by pillars of brass, 11, at either end. The vibrating spring, 5, is supported at its lower end upon a bar of brass, 12, to which it is secured with screws passing through a washer plate. This construction is essential in order that the spring may have a definite point or edge from which to vibrate.

The condenser to be shunted across the interrupter should be adjustable. The builder is strongly advised to purchase this condenser outright. The task of making up a condenser of tinfoil and paraffined paper is a discouraging one and the manufactured article can be purchased so

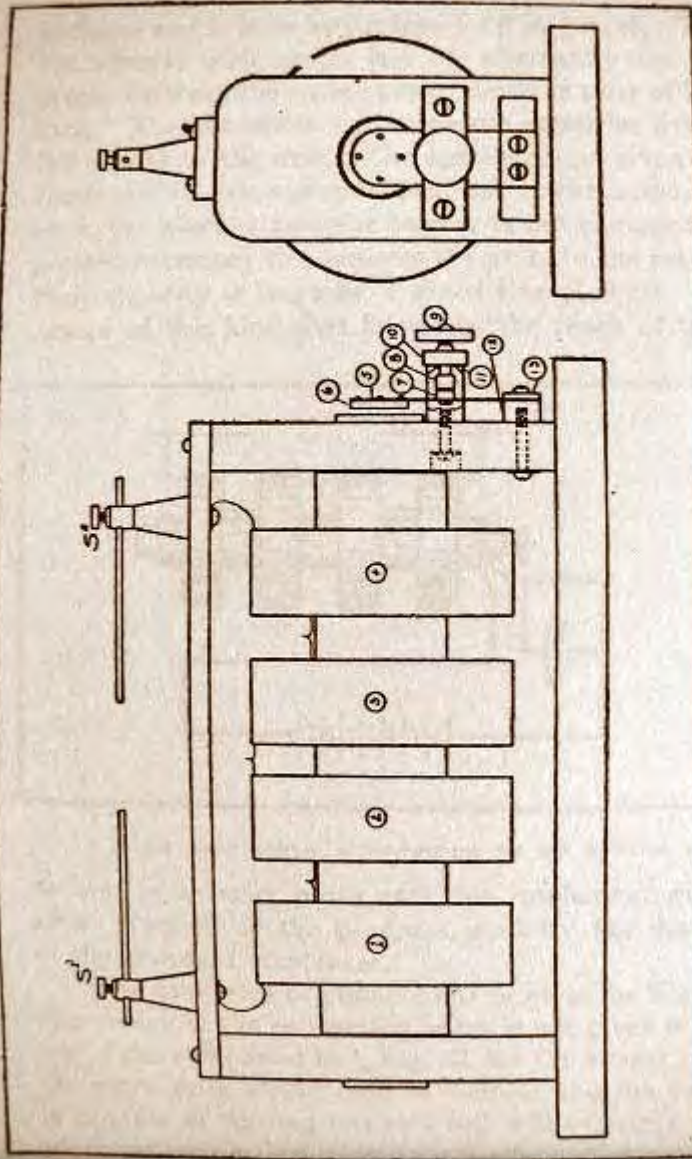

Fig. 32.—Induction coil complete showing relation of component parts

cheaply that the amateur builder is not justified in making one. The standard telephone condenser of 1 mfd. capacity is approximately correct in capacity and if four more sections of .5 mfd. each are added, the necessary range of adjustment is obtained.

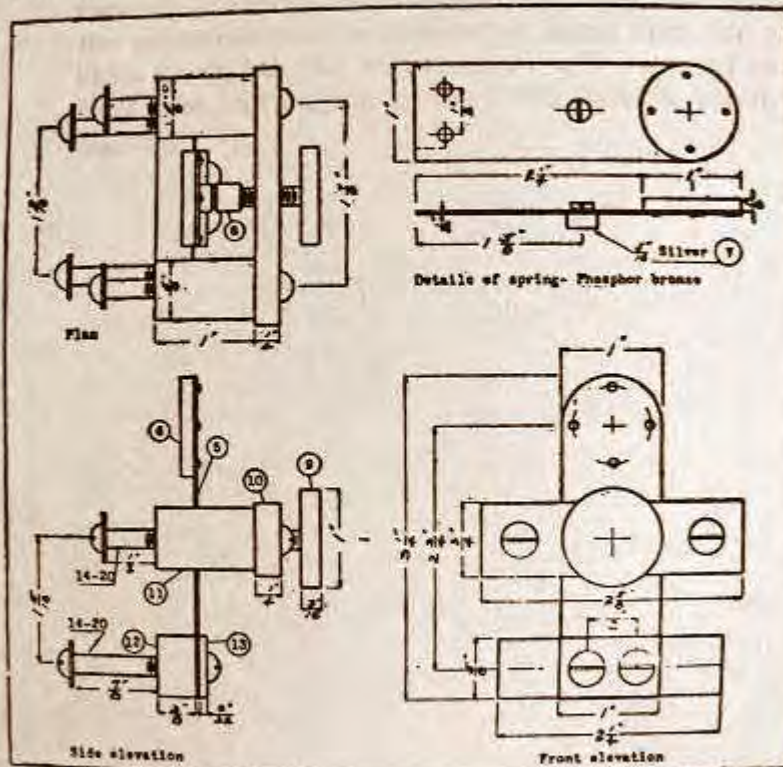

Fig. 33.—Details of the interrupter

If the builder wishes to make his own condenser, he may purchase 250 sheets of heavy paraffined paper such as is used to wrap candies in. This paper may be cut to form 500 sheets of paper 8 x 10 in. in size. The tinfoil should be thin in order that cost and weight may not be in-

ordinate and it is to be cut into 6 x 8 in. pieces. These tin-foil sheets, with strips laid on alternately for lugs, are placed between the waxed paper sheets in piles of 100 sheets each. The condenser will therefore comprise five units of 100 sheets to the unit. The specifications given are for a condenser of large proportions, but in the author's experience, the average amateur builder is not equipped with the presses necessary to compress the units to the extent where their capacity is large for a given size of sheet. The only device of this kind that is within the reach of the experi-

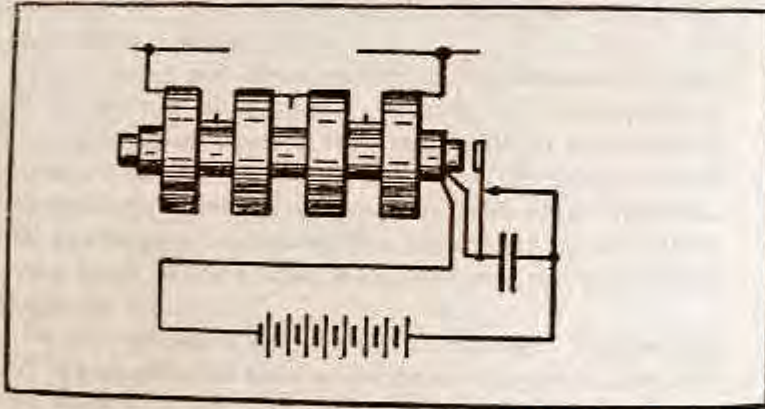

Fig. 34.—Diagram of connections for the induction coil

menter is a letter press and this implement gives but a small fraction of the pressure used by the manufacturer of the standard condenser.

The diagrams of connections is given in Fig. 34. The disposition of the connecting wires is not given in the drawing of the completed coil, Fig. 32, for the simple reason that the extra lines would tend to confuse and the builder who is capable of turning out this coil will certainly be able to place his connecting wires in a workmanlike manner.

High Tension Condensers.—The condenser for connection across the secondary of the induction coil may be made by coating both sides of an 8 x 10 photographic negative with tinfoil in sheets 6 x 8 in. in size. Probably but two or three of these condenser plates will be necessary if they are connected in multiple. For high frequency coils, the condenser will be somewhat larger than for general radio work, but the experimenter will not need to make more than half a dozen of the 8 x 10 plates to insure ample capacity.

CHAPTER VIII

KICKING COIL APPARATUS.

The possibilities of the "kicking coil" type of high frequency apparatus have long been recognized by manufacturers of electro-therapeutic outfits but, doubtless owing to the scarcity of published data on the subject, this simple and inexpensive generator of high frequency currents has not seemed to come in for its due share of popularity among amateur constructors.

The kicking coil is an oddity to the uninitiated electrical worker; it is merely a winding of comparatively coarse copper wire upon a core composed of a bundle of soft iron wires. In this simple coil, which is totally devoid of a secondary, is set up a current of sufficiently high potential to charge a condenser; this high potential is induced at every break of the circuit which permits current to flow through the coil.

Fig. 35 represents a circuit of this nature. The kicking coil *K* is connected at one end of its winding with one side of the supply circuit. The other end of the winding goes to the vibrating armature of an interrupter. From the stationary contact of the interrupter we trace this circuit of the primary of a Tesla or Oudin coil and thence back to the source of supply. A condenser is connected across the break and the primary of the oscillation transformer.

As the current flowing through the coil is interrupted, a high potential surge is set up. This current enters the condenser which discharges its load through the inductance

and across the interrupter contacts as soon as the latter close up sufficiently for the charge to leap this small air gap.

By making suitable adjustments of condenser and the ratio between the turns in primary and secondary of the oscillation transformer, a high frequency current of practically any desired frequency and voltage may be obtained, within the limits of the outfit's capacity.

The greatest merit of this apparatus is its ability to operate on either alternating or direct current circuits with merely a slight change in the number of turns in the wind-

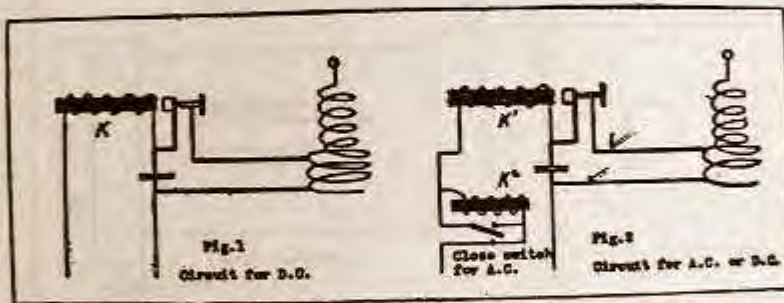

Figs. 35 and 36.—Wiring diagrams for the kicking coil apparatus

ing. While it is an undisputed fact that the "kicker" cannot compare with a transformer outfit on alternating current circuits, still it serves admirably in cases where direct current only is available.

The ideal outfit is, of course, one that will operate with workable satisfaction on both direct and alternating current circuits; the latter to comprise various frequencies found in common use. The design offered herewith incorporates all of these desirable characteristics through the introduction of a variable condenser and an extra kicking coil. The latter is short circuited when the outfit is used

on alternating current circuits. Fig. 36 gives a diagram of the connections.

This outfit is capable of doing effective X-Ray and general electro-therapeutic work within the inevitable limits of the portable outfit. The spark produced is of good quality and in length it reaches fully 7 inches. If the oscillation transformer were to be made larger in diameter,

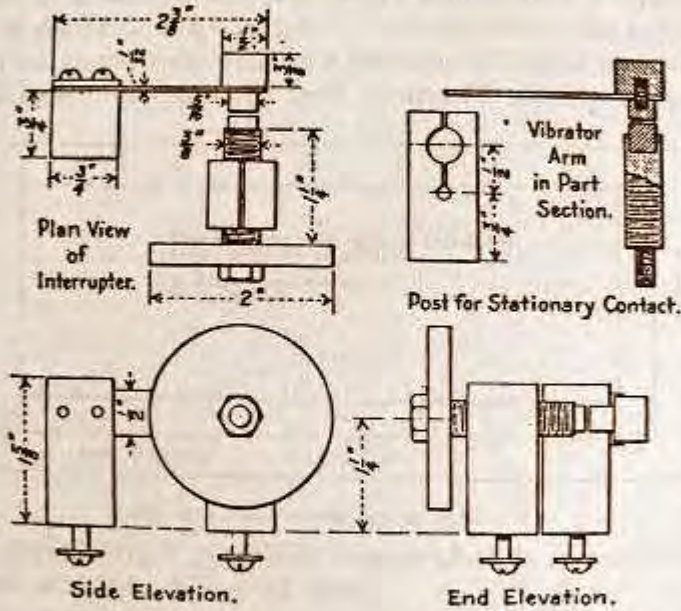

Fig. 37.—Details of the vibrating interrupter

the spark length could be materially increased without any alteration in the exciting apparatus.

For the lecturer or the experimenter the outfit is an exceptional one. It is light in weight, inexpensive and simple to build, and, as we have already noted, it is universal as regards current supply.

The Interrupter.—This is the one weak point in the

apparatus. While large and elaborate rotary contact breakers are more reliable in operation, they introduce too much weight and cost in an outfit of this nature. The next best is probably a simple vibrating interrupter with massive contacts similar to that shown in Fig. 37.

The posts for the interrupter should be of generous proportions as the drawing indicates. The stock is of $\frac{1}{4}$ in. square or hexagonal brass rod. The latter is preferable if the worker is possessed of a lathe as it may be conveniently gripped in the universal chuck for cutting, facing off and drilling.

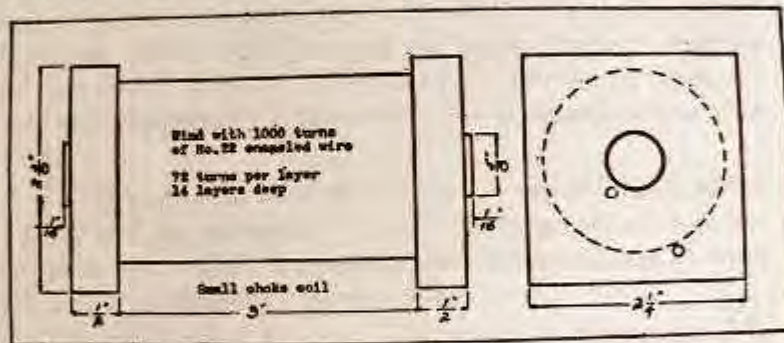

Fig. 38.—Small choke coil in detail

The spring should be of phosphor bronze; the thickness is preferably in the proximity of $\frac{1}{32}$ in. At one end of the spring is screwed the armature of soft iron or cold rolled steel rod. This is simply formed by cutting off a $\frac{3}{8}$ in. piece of $\frac{1}{2}$ in. rod. A hole tapped into the armature takes the short length of $\frac{8}{32}$ threaded rod that serves to hold the silver contact and armature to the spring.

The contact is cut from a length of $\frac{1}{8}$ in. pure silver rod. The little cylinder is to be drilled and tapped to a depth of $\frac{1}{8}$ in. to take the $\frac{8}{32}$ rod.

The stationary contact is so designed that the tension

of one contact against the other may be regulated to a nicety. This is effected through the medium of a fine thread on the adjusting screw which is of $\frac{3}{8}$ in. diameter brass rod. The silver contact cylinder is driven into a hole drilled in the end of the adjusting screw. The reverse end of this screw is tipped with a fibre knob of good size.

The Choke Coils.—The smaller of these coils, Fig. 38, serves as a magnetic device to actuate the interrupter. It consists of a core of soft iron wires formed into a bundle $\frac{5}{8}$ in. in diameter and 4 in. long, covered with several layers of empire cloth; over this is a winding of 1,000 turns of No. 22 D.S.C. or enameled wire wound 72 turns per layer

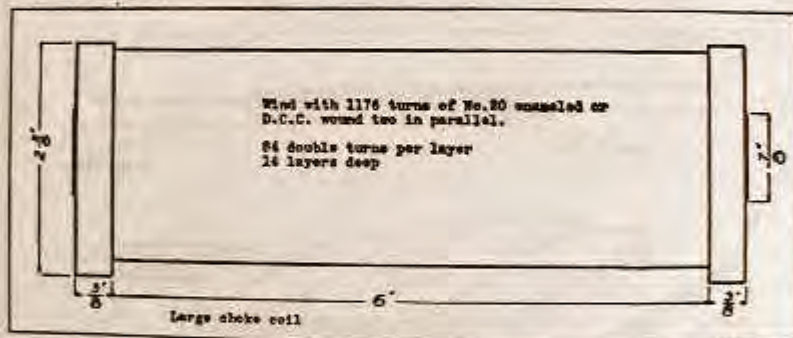

Fig. 39.—Large choke coil in detail

and 14 layers deep. A turn of empire cloth is interspersed between each two layers of wire.

The core is supported between heads of fibre that fit closely over the bundle of iron wires. A good construction is to form a spool of fibre tubing with square fibre heads; forcing the core wires into the tube after the winding is completed. As the drawing shows, the layers of wire do not come quite out to the end of the layer of insulating cloth; this affords ample protection to the end turns which are subjected to maximum potentials.

The larger of the coils is shown in detail in Fig. 39. The core is $6\frac{1}{4}$ in. long and $\frac{7}{8}$ in. in diameter. The winding is of No. 20 D.C.C. wire wound two in parallel. Each layer comprises 84 double turns and there are 14 layers in all. The same rules as to insulation apply as in the case of the small coil.

The Condenser.—This is of the glass plate variety in the present design. If the builder cares to invest in mica plates of the same size, he will effect a material saving in space and weight.

The glass to be used is of the variety known as "lantern slide cover glass." As the name implies, the glass is used to cover the photographic positive in a lantern slide. The cover glasses are thin and perfectly free from bubbles and the usual defects. They may be purchased from almost any photographic dealer and the standard size is 3 x 4 inches.

For the condenser at its maximum capacity, 200 plates of glass will be required. While this large capacity is not always in use, still it is essential for certain classes of work and it should therefore be provided.

The conductor for the condenser is heavy tin foil. This comes in sheets $6\frac{1}{2} \times 8\frac{1}{2}$ in. and 27 sheets weigh a pound. For our condenser 200 pieces are to be cut $3\frac{1}{4} \times 4\frac{1}{4}$ in., and for this operation a photo trimmer is well adapted; lacking this, the foil may be placed on a large sheet of glass and cut with a sharp knife.

The condenser is to be assembled into 20 units of ten plates each. This makes for convenience of adjustment. Each little unit will have a capacity of approximately .005 mfd. and the entire condenser therefore reaches .1 mfd.

When the assembly is started the builder should provide himself with a small gas or spirit lamp, a lump of

HIGH FREQUENCY APPARATUS

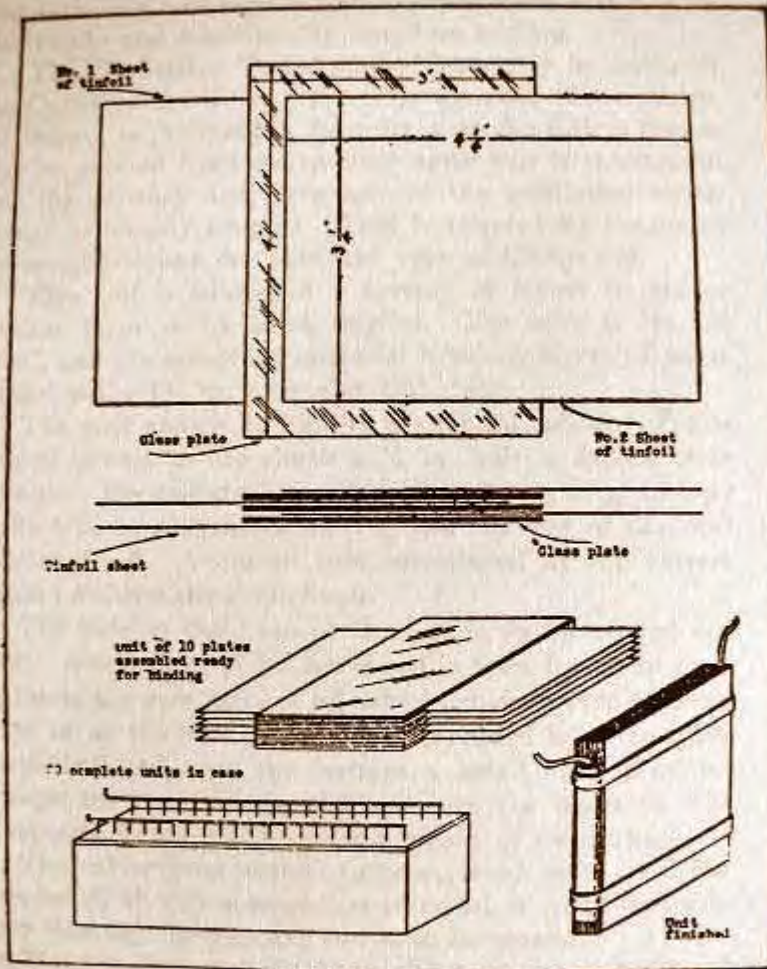

Fig. 40.—Details of the condenser
beeswax, and a tuft of cotton wrapped in a piece of soft
cloth. These accessories on a work table, with the clean
glasses and sheets of tin foil, will enable the worker to
proceed.

With reference to Fig. 40, the first plate of each unit is to have its foil sheet projecting to the left. This leaves a margin of $\frac{3}{8}$ in. on three sides. This first sheet of foil is to be secured to the plate in the following manner:

Slightly warm the glass over the flame and immediately touch with the beeswax; spread the latter is a very thin layer with a tuft of cotton. Place the foil sheet in position and rub into perfect contact, using the dauber, and working outward with a circular motion.

When this first sheet has been secured to the glass, the latter may be placed on the table with the foil underneath and projecting to the left. A touch of the wax to the upper side of the plate and the second foil sheet may be laid on; this is to project to the *right* with a margin of $\frac{3}{8}$ in. on top, bottom, and left side. Next comes a piece of warm glass with its drop of wax; then the third sheet of foil which projects to the *left* the same as sheet No. 1. On this is the third plate of glass, fourth sheet of foil, and so on until 10 sheets of foil and ten plates of glass have been assembled as shown in Fig. 40.

The object of the drop of wax is merely to insure that the glass and foil sheets will maintain their relative positions during assembly. The unit is now to be "backed up" on either side with a piece of cardboard. The projecting lugs are rolled up with a piece of $\frac{1}{8}$ in. copper ribbon enfolded, and the entire unit bound firmly with linotape at top and bottom. This general procedure is to be followed with each of the 20 units which will then be ready for impregnation.

In a double boiler, melt equal parts of beeswax and rosin; in this compound suspend the condenser units for two hours. If the wax has been kept sufficiently hot the interstices between the glass plates will be completely filled

and each unit will form a homogeneous mass that is both electrically and mechanically sound on cooling.

The Oscillation Transformer.—This may be either of the Oudin or the Tesla type. For the sake of simplicity, the former is preferable. In order that the fullest benefit may be derived from the exciting apparatus it is essential that the primary and secondary of the oscillation transformer be closely coupled. This is effected by means of the spirally-wound or "pancake" type of Oudin coil.

This coil is wound in a success of layers in flat or pancake form as its name implies. The wire is No. 30 D.C.C. and the insulating material between layers of wires is oiled paper $1\frac{1}{2}$ in. wide and .003 thick.

The post shown in Fig. 41 is of hard rubber. While the rod is held in the chuck a $\frac{1}{4}$ in. hole is drilled clear through. The tail stock center is then brought up to bear in the hole to prevent chattering and the end of the post is finished off. A cut-off tool introduced at the correct position finishes the rubber rod.

The hole at the base of the rod is to be tapped out $\frac{3}{16}$ -18. A length of $\frac{1}{4}$ in. brass rod is then forced in from the top of the post and cut off when it has entered to within $1\frac{1}{2}$ in. of the base. The top is threaded to enter a discharge ball and near the bottom a small hole is drilled through the hard rubber rod and into the brass to take an escutcheon pin which forms a means of connection.

The rubber post is then to be screwed on to an arbor threaded $\frac{3}{16}$ -18 with a large disc of metal or wood between. Upon this rig, the pancake coil is to be wound.

The winding may be done either in the lathe or, if none is available, in a simple, home-made winder. The starting end of the wire is soldered to the head of the escutcheon pin that makes connection with the central rod. Taking three turns of the oiled paper over the rubber post,

and turning the lathe backwards or away from him, the worker may start the winding over the oiled paper. The first layer must have its turns separated $\frac{1}{8}$ in. Over this

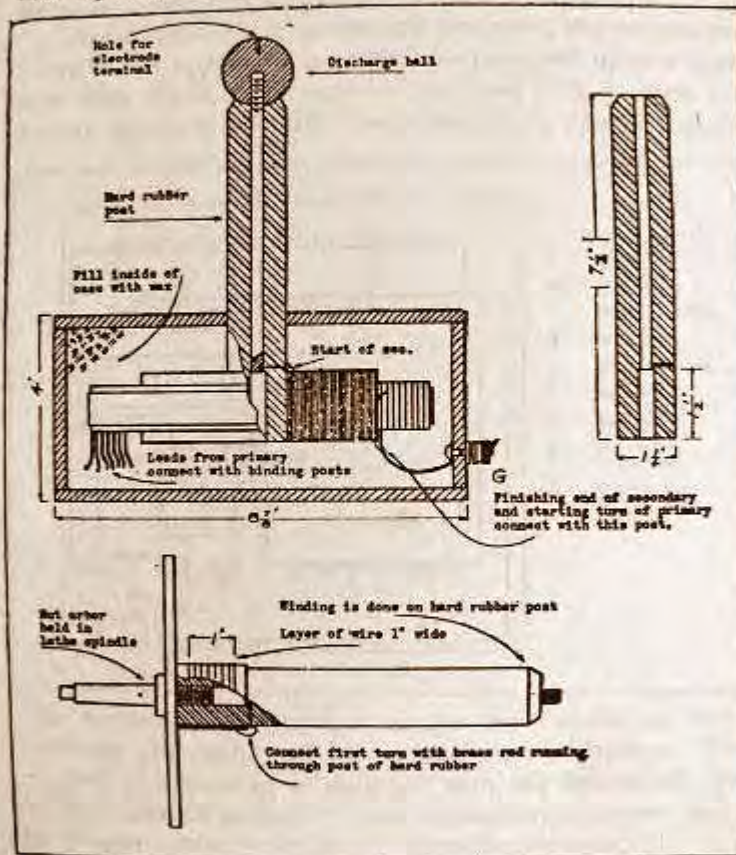

Fig. 41.—Details of the oscillation transformer
layer of wire are placed three more layers of paper; then another of wire with turns spaced $\frac{1}{8}$ in. This is repeated until 50 layers are in place, the turns being gradually

placed closer together until, with the 50th layer, they are separated only $1/32$ in.

From this point on and until the 150th layer, which completes the coil, has been wound, the turns may be spaced about 32 to the inch. The layers should be but one inch in width in order that a margin of $1/4$ in. may be left on either edge. The final layer of wire is to be covered with 10 layers of oiled paper, the end of the winding being brought out ready for connection with the primary.

The primary consists of 10 turns of copper ribbon, 1 in. wide, wound spirally around the secondary pancake. Between the turns of the primary is a strip of corrugated board such as is used for packing purposes. The finishing end of the secondary is soldered to the starting end of the primary and at this point a length of flexible lamp cord connects to the junction of the two. The ten primary turns are then wound and a tap of lamp cord taken from the upper edge of each of the turns from the third to the tenth inclusive. This provides a means of varying the primary inductance while tuning the apparatus. The final primary turn is held mechanically by means of a wrapping of several layers of oiled paper; the latter may be shel-lacked in place.

Removing the coil from the lathe, we now have the complete winding ready for impregnation with the compound already suggested for the condenser. The entire coil is to be immersed in the molten wax for several hours and, before its removal, the heat should be withdrawn in order that the mass may partially congeal. As the wax shrinks on cooling, it is essential that the substance be permitted to contract within the coil.

While the winding is being treated, the worker may build the box that is to contain the oscillation transformer.

The case may be square and deep enough to permit of an inch of wax above and below the coil. It is obvious that the box must be wax-tight for the molten compound is to be poured into this container.

Assembly.—For experimental purposes, the component parts of the apparatus may well be mounted upon a common base board. For portable purposes such as upon the lecture platform or with the physician, a cabinet totally

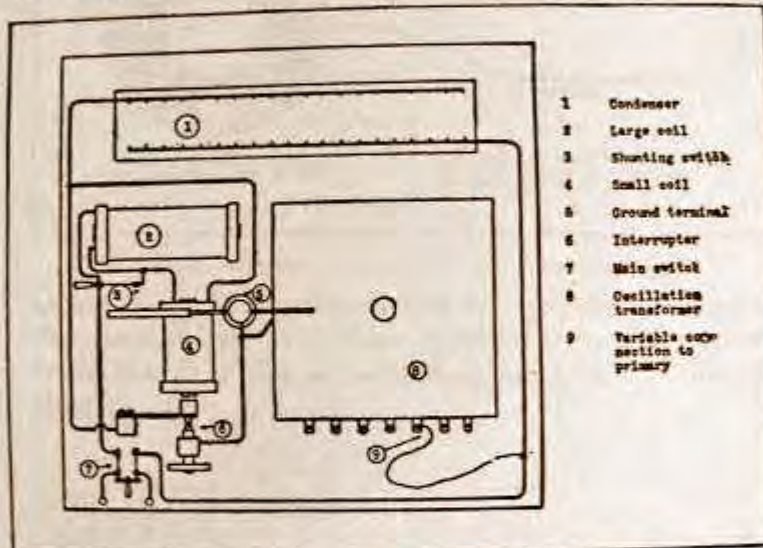

Fig. 42.—Suggestion for assembly of apparatus upon a common base board enclosing the outfit will be found more satisfactory. The method of mounting is optional with the individual and, for the sake of simplicity, the apparatus is shown ready for use on a base board in the appended drawing.

The connections will be clearly understood on reference to the diagram in Fig. 36. For direct current work, the large kicking coil is left in the circuit, while for use on alternating currents, it is short circuited with the single-

pole, single-throw switch shown in the illustration. The letters "A.C." and "D.C." should be plainly stamped beneath the respective clips of the switch as indicated in the diagram to prevent possible confusion.

The capacity of the condenser is varied as may be found necessary by means of the copper strips which are forced into the clips projecting from the condenser case.

In operating the apparatus, the adjusting knob of the interrupter should be in the "open" position. Turn the current on and screw the contact in gradually. As soon as contact is made, the interrupter will begin to vibrate and a sputtering spark will form at the break of contact. The operation should start with about half of the condenser capacity thrown in and with half of the turns of the Oudin coil primary in use. Perhaps a spark will be in evidence at the ball terminal of the oscillation transformer if the ground terminal is brought up to within a couple of inches of the ball. If not, try an adjustment of the capacity in the condenser or a variation of the primary turns. This will show some improvement and the operator may then screw in the vibrator contact a bit further; a considerable increase in length and thickness of spark will result. A further adjustment of capacity or inductance and a tentative tightening of the contact will tune the apparatus perfectly until the maximum results are obtained.

Electro-therapeutic Work.—The outfit described is admirably adapted for light X-Ray and vacuum tube work. If a D'Arsonval current is desired for auto-condensation, the builder is strongly advised to make a second oscillation transformer in which the primary has five turns and the secondary ten turns of copper ribbon. This coil may be simply constructed by winding up 15 turns of $\frac{1}{2}$ in. copper ribbon in a flat spiral with a strip of the corrugated paper between to insulate one turn from the other. The kicking

coil current is sent through the inside turns, say up to four or five, and the D'Arsonval current for the couch is taken from the remaining turns. The diagram, Fig. 43,

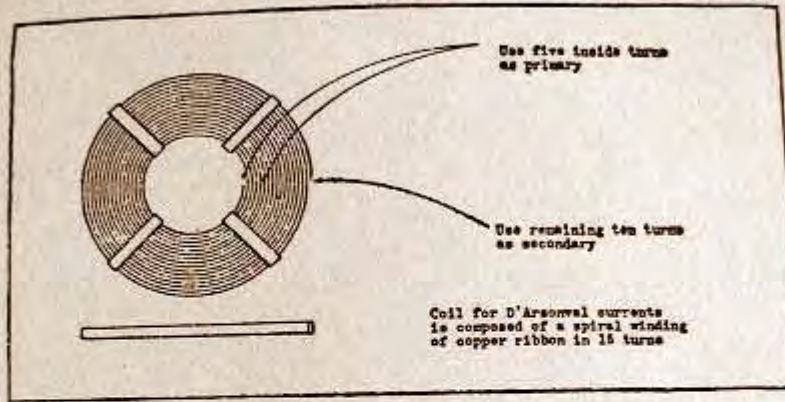

Fig. 43.—Coil for the production of D'Arsonval currents

makes this perfectly clear. The coil may be sealed up in a flat wooden case with taps brought from the respective turns of copper ribbon to binding posts on the outside of the case.

CHAPTER IX.

ONE-HALF KILOWATT TRANSFORMER OUTFIT.

If the experimenter is the fortunate possessor of a supply of alternating current from electric lighting mains, he may well devote his energies to the construction and use of transformer apparatus rather than bother with either the induction coil or kicking coil outfits previously described. The transformer is easily and cheaply made, and, in results, it is, beyond any doubt, superior to any other device for the charging of condensers.

The Core.—The transformer core is composed of thin sheets of silicon steel which is prepared expressly for transformer cores. The core is built up to form a hollow rectangle as shown in Fig. 44 which gives the overall dimensions. The first step is to procure the silicon steel cut to size; this procedure is recommended rather than attempting to cut the large sheets in the home workshop. Unless a gate-shear is available the job is a slow and very unprofitable one as the pieces will not lie flat if cut with an ordinary pair of tinner's shears. The core irons may be purchased cut to size at a reasonable price.

The core irons are procured in two sizes, Fig. 45, for the ends or legs of the core and for the sides or yokes. Of each size, 230 pieces will be required. The windings are placed on the shorter legs of the core, *i. e.*, the legs made up of the $2 \times 4\frac{3}{4}$ in. pieces. These pieces are to be built up in two piles, the pieces being placed with ends overlapping alternately first to the right and then to the left for

a distance of 2 in. as shown in Fig. 45. When each bundle has been built up to a thickness of 2 in., friction tape should be wrapped around the center or winding space to

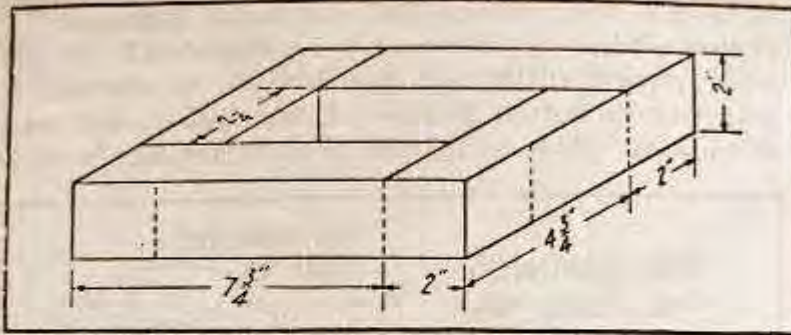

Fig. 44.—Core of transformer with dimensions

compress the sheets into a compact bundle. If the sheets are clamped in a vise and the tape wrapped around the projecting end, the core may be tightly bound as the bundle is released an inch at a time.

After the two bundles have been formed, they may be joined by interleaving the $2 \times 7\frac{3}{4}$ in. pieces to form a yoke between the short legs. The fourth side of the hollow rectangle is not to be built up until after the windings have been placed in position.

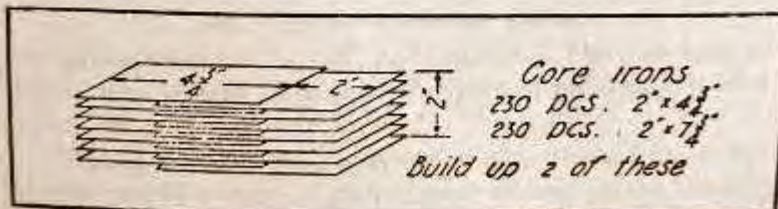

Fig. 45.—Short leg of core upon which winding is placed

Primary Winding.—Fig. 46 gives the data for the primary winding to use for any of the commercial frequencies.

The core is so generously proportioned and the quality of iron specified so good that the only change necessary for use on various frequencies is in the number of turns of wire.

The primary is wound upon the form illustrated in Fig. 48. If the builder has a lathe, the form may well be mounted upon an arbor or even upon the faceplate. The No. 14 D.C.C. wire is wound upon a base of several layers of oiled paper $2\frac{1}{2}$ in. wide. In preparing the form for the

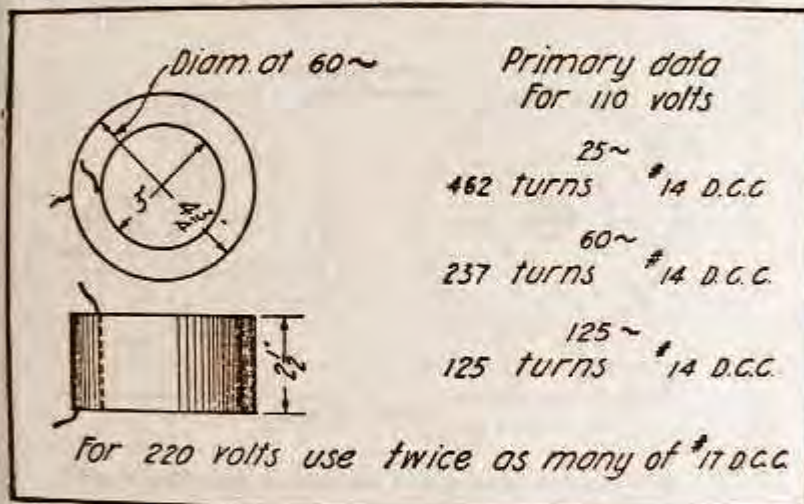

Fig. 46.—Data for primary winding

winding, a layer of cord is first wound over the wooden drum, and the base of oiled paper placed over this layer of cord. The object of the cord is, of course, to permit the winding to be removed by pulling out the cord.

Between each layer of wire and its neighbor, four turns of the oiled paper should be taken. This will make the winding, firm and smooth and it serves further to aid in the insulation. The winding, when completed, is given a liberal coating of armalac. The starting and finishing ends

of the winding are soldered to lengths of incandescent lamp cord which are subsequently joined to the primary binding posts.

Secondary Winding.—The secondary data is given in Fig. 47. This winding is of enameled wire and the method of procedure is identical with that of the primary. The same form is used and the winding started upon a heavy layer of micanite sheeting cut $2\frac{1}{2}$ in. wide. In all, this

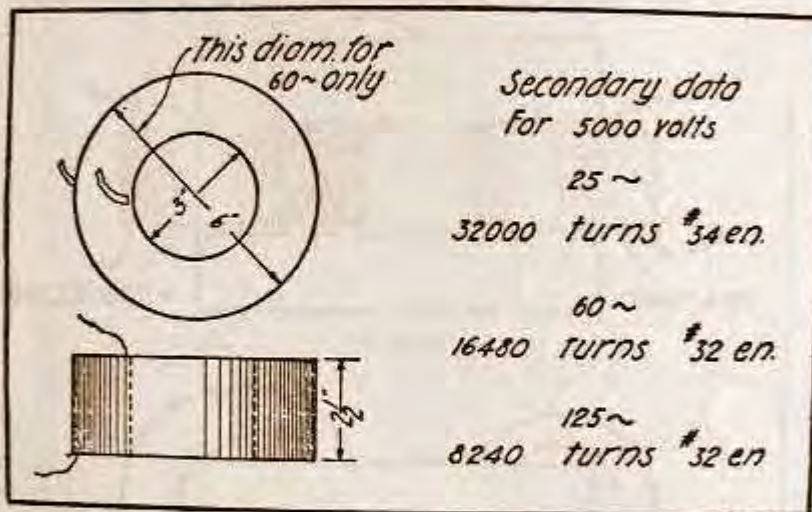

Fig. 47.—Data for secondary winding

insulation should be about $\frac{1}{16}$ in. thick. The top turn of micanite is covered with several layers of oiled paper, after which the winding may start.

Before starting the paper turns over the micanite, the builder places a strip of thin copper ribbon across the micanite. Over this the paper is wound. The starting end of the fine wire is to be soldered to the tip of the copper ribbon and as the layer of wire is wound, the ribbon is securely held. The layers of wire in the secondary are to be

2 in. wide to leave a margin of $\frac{1}{4}$ in. on either side of the wire. Two turns of oiled paper are taken over each layer of wire before the next layer is wound. The finishing layer of wire is terminated in a second copper ribbon which forms the secondary lead for connection to the high tension terminals. Over the final layer of wire, several layers of oiled paper are wound to form a mechanical protection for the delicate wire. The edges of the coil are well soaked with armalac and the secondary is then ready to mount, after the compound has dried.

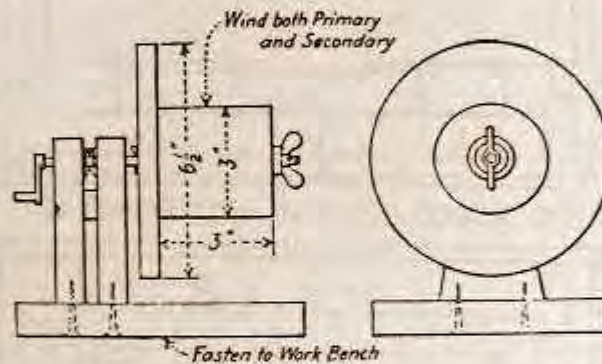

Fig. 48.—Winding machine for both primary and secondary

Assembling and Mounting.—In Fig. 49 the complete transformer is shown with primary and secondary in place and the remaining core irons in position to complete the magnetic circuit. The space between the winding and the core is to be partially filled with wooden plugs, carefully whittled to fit the space without forcing.

Fig. 50 suggests the mounting for the complete transformer. The case may be of mahogany, oak or whitewood. It is built to fit the transformer and as the windings for different frequencies change the diameter of both primary

and secondary, and consequently the length of the complete transformer, the dimensions are not given in the drawing. The core is gripped between lengths of wood and the latter pieces are secured by means of screws passing through the walls of the case.

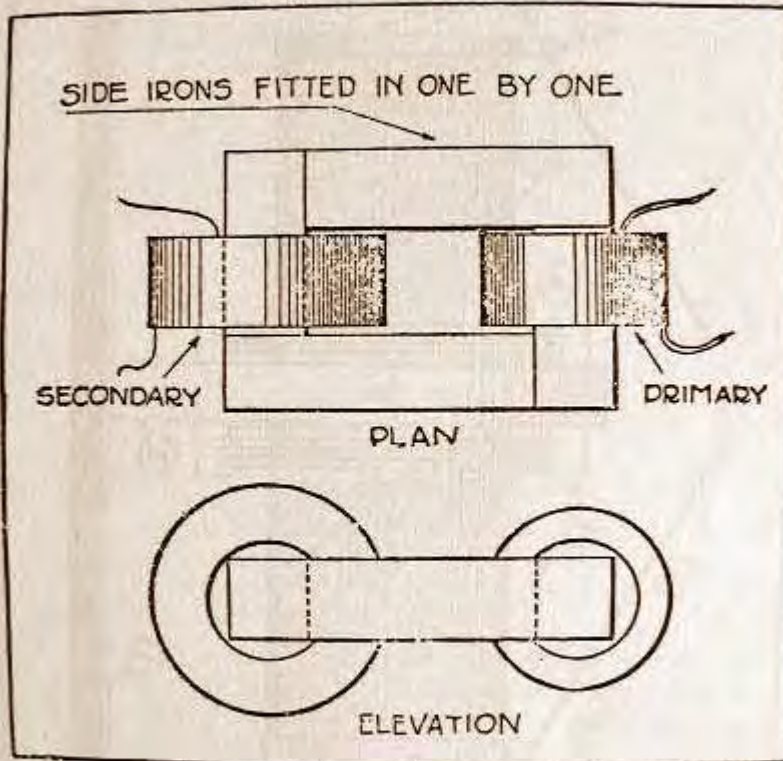

Fig. 49.—The transformer assembled

The primary and secondary leads are brought to suitable terminals in the case and the job is finished. For safety to the transformer secondary, a permanent gap should be affixed to the secondary terminals as shown in

Fig. 50. This gap is to be not more than $\frac{1}{2}$ in. in length.
Oudin and Tesla Coils.—Fig. 51 suggests the design for a very practical form of Tesla coil that is easily and cheaply built. Fig. 52 gives the data for an Oudin coil, the construction of which is very similar to that of the

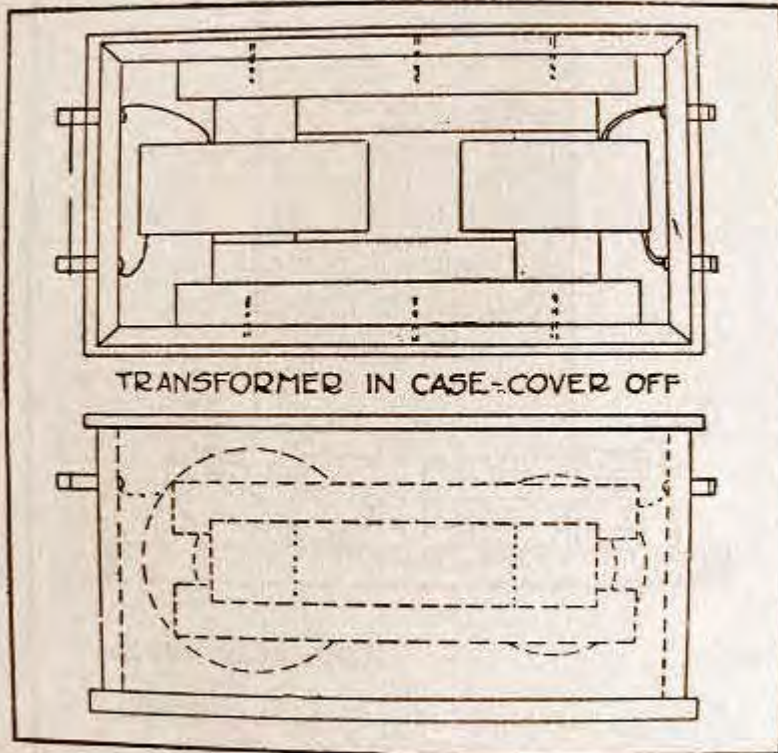

Fig. 50.—Transformer in its case

Tesla. The description herewith will accordingly be devoted to a discussion of the latter type only.

With reference to Fig. 51, the base, 1, is of suitable dry wood as is also the upright support, 2. The dimensions

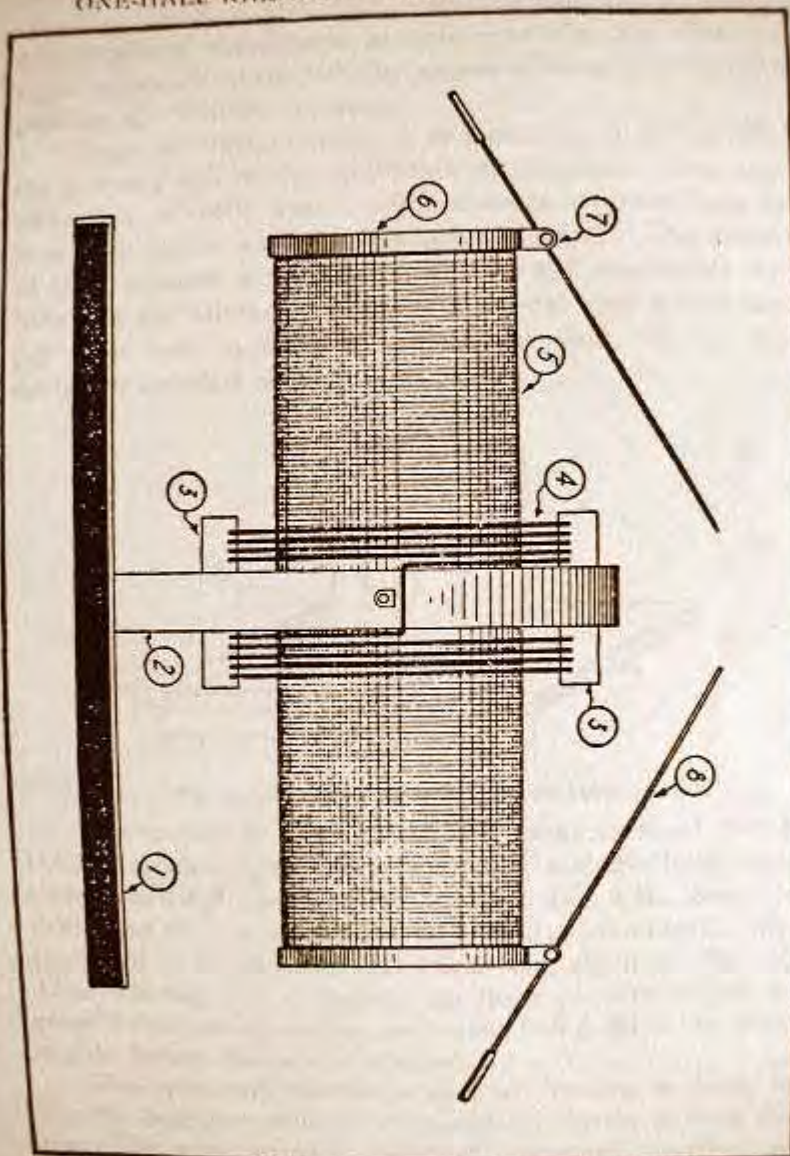

Fig. 51.—Oscillation transformer composed of two Oudin resonators placed base to base

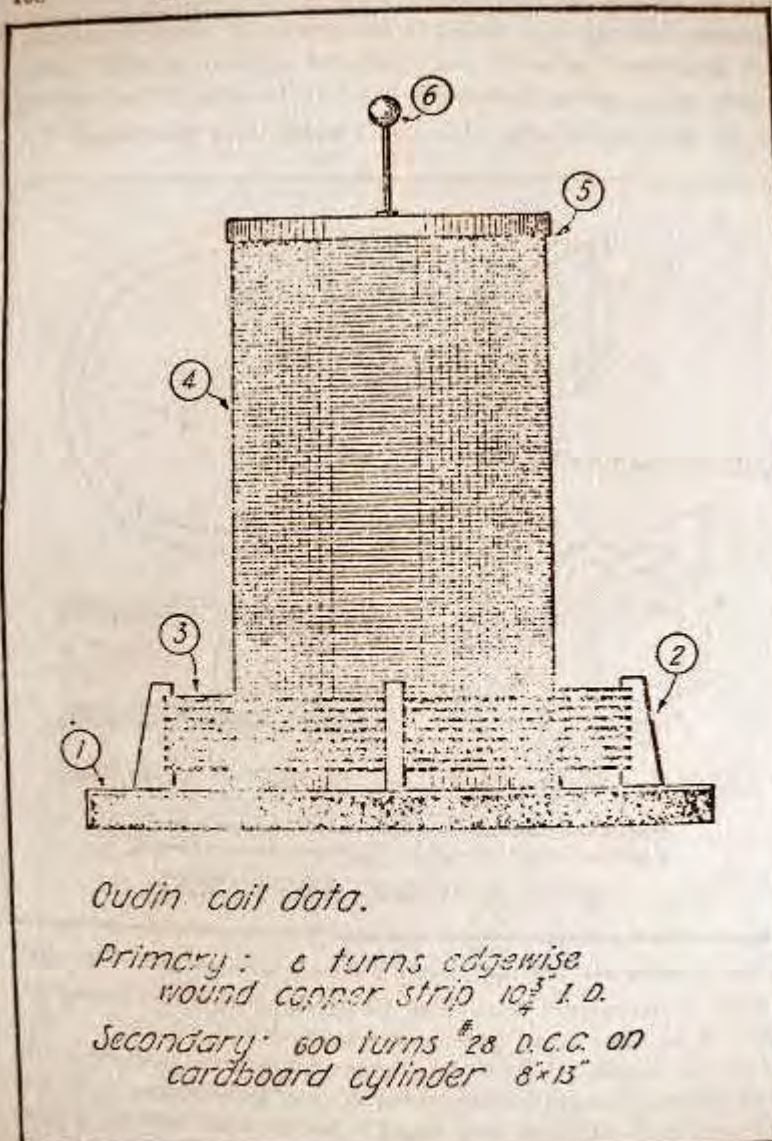

Fig. 52.—Data for Oudin resonator

and details of these parts are given in Fig. 53. The upright is secured to the base by means of stout brass screws passing up through the base.

Upon the upright piece, 2, is mounted, on either side, the primary coil of the oscillation transformer. The complete coil is really two Oudin resonators placed base to base with primaries and secondaries in series. The details of the primaries are given in Fig. 11 and the reader will note that the primary conductor is of edgewise wound copper strip, held in suitable supports of fibre. These supports are detailed in Fig. 54 at 3.

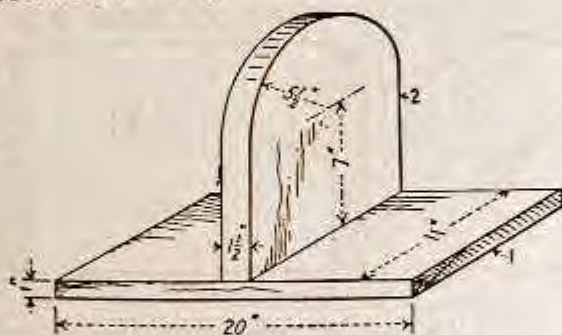

Fig. 53.—Woodwork for oscillation transformer.

The secondary coils are of 400 turns each, of No. 30 D.C.C. copper magnet wire, wound in a single layer upon a cardboard cylinder 6 in. in diameter and 8 in. long. In either end of each cylinder, a wooden head is affixed. The details of the cylinders and heads are given in Fig. 55. After winding the cylinders, the layer of wire should be given five coats of shellac, each coat being dried out thoroughly before the next is applied.

The secondary discharge rods are shown in detail in Fig. 54, together with the clips which hold the ball on the rod. The two primary coils are connected together as

nately first to right and then to left in the usual manner and these lugs soldered to a common connector on either side of the unit.

The spark gap, Fig. 57, is simple in construction. This design is quite satisfactory, however, for experimental work on small-powered outfits. The electrodes are of battery zinc, $\frac{3}{8}$ in. diameter. A single zinc cut in two will answer well. The electrodes are held in supports of brass rod, suitably drilled and held upright upon a base that should preferably be of marble. If marble is not available, hard

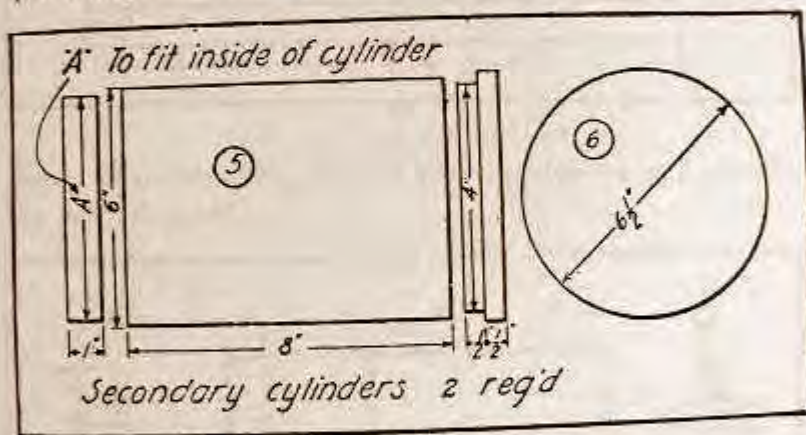

Fig. 55.—Details of secondary cylinders

wood will answer. Slate should not be used as the minute metallic veins found in some varieties render the substance unsuitable for this purpose.

Connecting and Using.—Fig. 58 shows how to connect the apparatus. The spark gap is placed across the secondary terminals of the transformer. The condenser is inserted in one lead from the gap to the primary of the Oudin or Tesla, while the other connection from the primary goes back to the gap.

When the current is applied, the ball of the Oudin or

the discharger of the Tesla should give out a large brush discharge of purplish fire. If the first trial does not result in this, try a variation of the primary turns of the oscillation transformer. This, together with a variation of the spark gap, will serve ultimately to bring the apparatus to the point of resonance. The Tesla coil will give a full 16 in. spark with the $\frac{1}{2}$ k.w. transformer described in the early part of this chapter.

The spark from the oscillation transformer is perfectly harmless if taken through a metal rod grasped firmly in the hand. No sensation of shock whatever will be experienced.

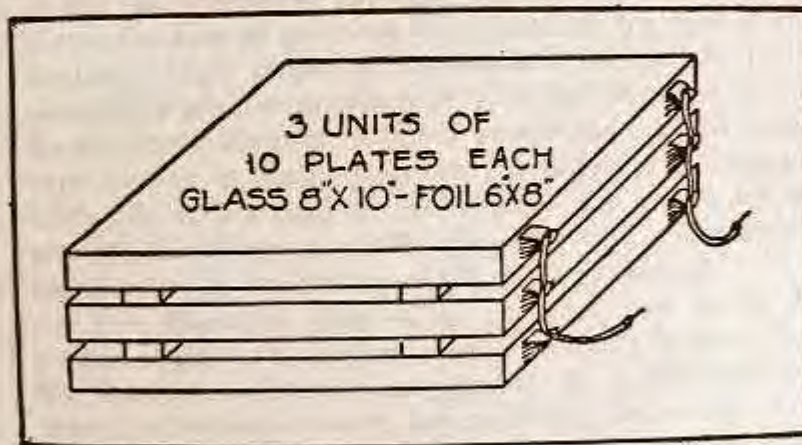

Fig. 56.—Data for the condenser

If the discharge touches the bare skin, the current will leave a blister if applied for any length of time in one spot. Aside from this unpleasantness, no direful results may be expected.

Whenever the apparatus is operated, the ground connection shown in Fig. 58 should be religiously made. This connection will protect the windings of the low frequency transformer and also the line wires and meter in the house.

For further protection from "kick back" on the line, place two small telephone condensers in series across the line

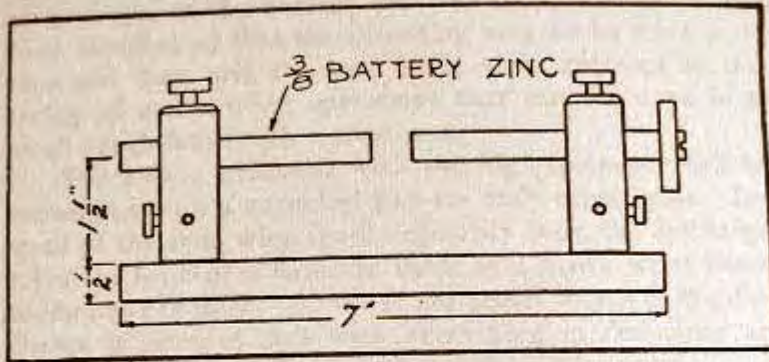

Fig. 57.—Simple zinc spark gap

wires where they connect to the transformer and ground the neutral point.

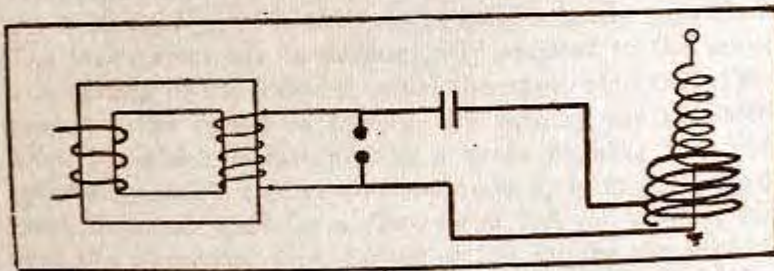

Fig. 58.—Diagram of connections

CHAPTER X.

QUENCHED GAP APPARATUS.

Comparatively few experimenters with high frequency current phenomena and apparatus within the acquaintance of the author have used the quenched gap in their experimental work. Possibly this is due to the scarcity of data on the construction of gaps adapted to the purpose; possibly to the lack of practical knowledge on the part of the workers. High frequency apparatus is so easy to build, and with a given expenditure of time and labor the results are so great with even mediocre equipment that the casual experimenter is likely to devote his hours to making the sparks fly rather than to devise ways and means for increasing the efficiency of this apparatus with a corresponding increase in the quality of the results obtained.

The Quenched Gap.—The quenched gap to be described combines a number of very desirable features from the amateur mechanic's standpoint. It is admitted that there are certain inherent defects in the design, but these have to be tolerated in order that the gap may come within the limits of the amateur's shop equipment, which is usually confined to a small bench lathe and a few other tools. One improvement that might be made in the gap is to be noted in connection with the means for adjusting the distance between the electrodes. If the upper electrode 2 were cast in one piece integral with the hub or spindle 3 the gap might be varied in length by threading the spindle through the top frame plate 5. This construction presents

some very fine machine work, and a screw-cutting lathe is positively essential. Assuming that the latter tool is not to be found in the average amateur shop, the design has been modified so that the threading may all be done with taps and dies, and the only lathe work required is the facing-off and drilling operations that may be done in a small bench lathe with a slide rest.

The effects produced with the high-frequency coil in connection with a quenched gap are truly remarkable. Instead of the thin, wiry spark ordinarily seen, the discharge takes the form of a flame as thick as a man's wrist when conditions are right. At times the actual length of the discharge is reduced, but with everything in resonance an increase both of thickness and length will be noted.

With reference to Fig. 59, which is a sectional view of the complete gap, the reader will note the instrument is comprised of two cast copper electrodes, 1 and 2, which are held rigidly, with their faces only slightly separated. The lower electrode is permanently secured to the lower iron casting of the frame 6, while the upper electrode is arranged to be raised or lowered by turning the insulated knob 14, which is fastened to a brass bushing 13. The spindle 3, which carries the electrode 2, is of cold-rolled steel, threaded $\frac{7}{16}$ -18 for a distance of $1\frac{3}{8}$ in., when it enters the electrode, then turned to $\frac{1}{2}$ in. for the central portion and finally threaded for $1\frac{5}{8}$ in., with the $\frac{7}{16}$ -18 die for the remaining portion.

The electrode is held from turning by the two steel pins 7, which are driven into holes in the electrode and which slide freely in holes in the frame above. Obviously, therefore, the movement of the upper electrode is a vertical one without any twist or turn. The coiled spring 8, serves to keep the necessary tension on the movement.

The builder will be required to do some simple pat-

tern making, but this need not alarm him. It is to be deplored that the average amateur has such a pronounced antipathy to anything in the nature of a pattern or a casting, whereas the latter is frequently the simplest way out of a given difficulty. The pattern for the electrode castings is illustrated in Fig. 60. It is turned out of a block of white-wood secured to the faceplate of the lathe, care being taken to leave the extra stock on the edge to provide the necessary draft. When the pattern has been turned out it should be sent to the nearest foundry for a pair of copper castings as nearly pure as the shop can supply.

Given the copper castings the worker grips No. 1 in the lathe chuck by the outer edge with the sparking face of the casting next to the face of the chuck. A good chip is taken off the projecting portion to remove the scale and the face finished with a light cut. The centering tool is then brought up in the tailstock and the casting centered. A $\frac{3}{8}$ drill is next run very carefully through the casting and this is followed with the $\frac{1}{8}$ -18 tap, which should be started with the tailstock center against it to insure accuracy. The hole threaded, the casting may be removed from the chuck and laid aside temporarily while exactly the same operations are done on the No. 2 casting. This latter must also have holes drilled to take the pins 7 after the casting has been removed from the lathe. So far the worker will have faced off the hubs of the castings and provided the tapped holes for the spindles, and this in a manner that insures that the spindle will be truly at right angles to the plane of the hub.

The next operation is to prepare the spindles for facing off the sparking surfaces of the castings. The spindle 3 is first prepared. It is to be used as an arbor upon which both castings are faced off. A piece of $\frac{1}{8}$ in. diameter cold rolled steel rod is cut off 4 in. long and each end faced

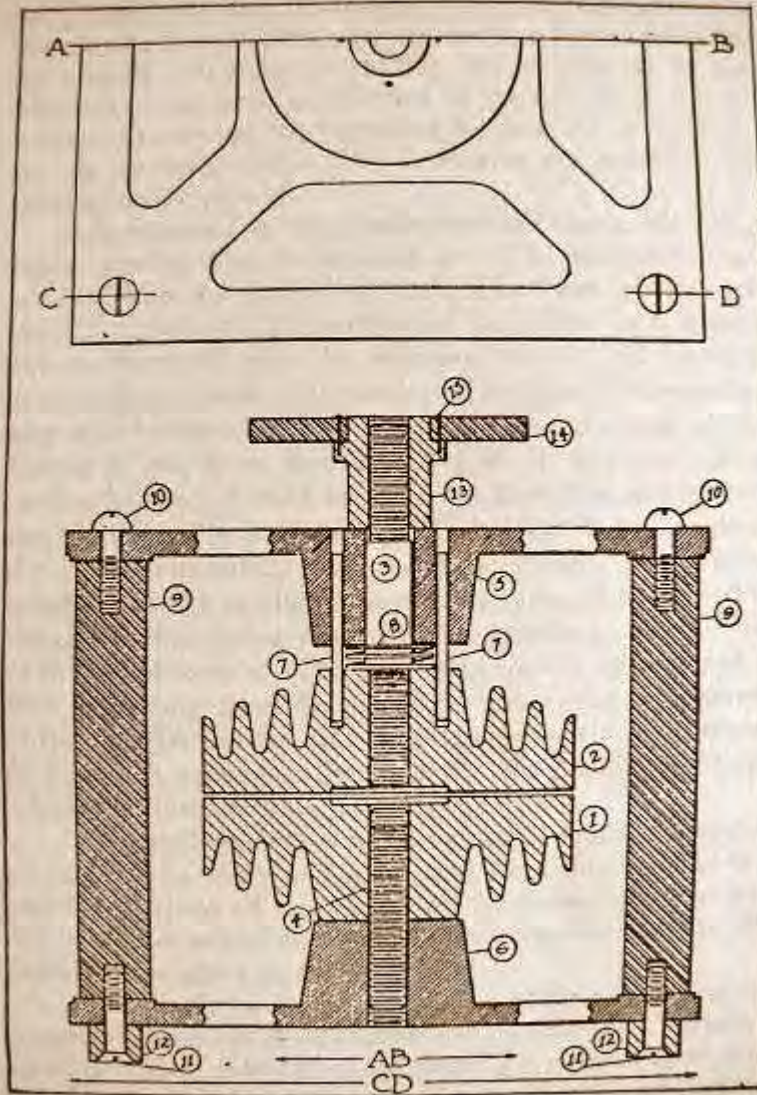

Fig. 59.—Half-plan and cross-section of the quenched gap

off and centered in the chuck, bringing its length down to $3\frac{3}{8}$ in. Holding the rod in a dog between lathe centers, a light cut is taken for a distance of $1\frac{1}{8}$ in., bringing the diameter eventually down to $\frac{1}{8}$ in. after several cuts have

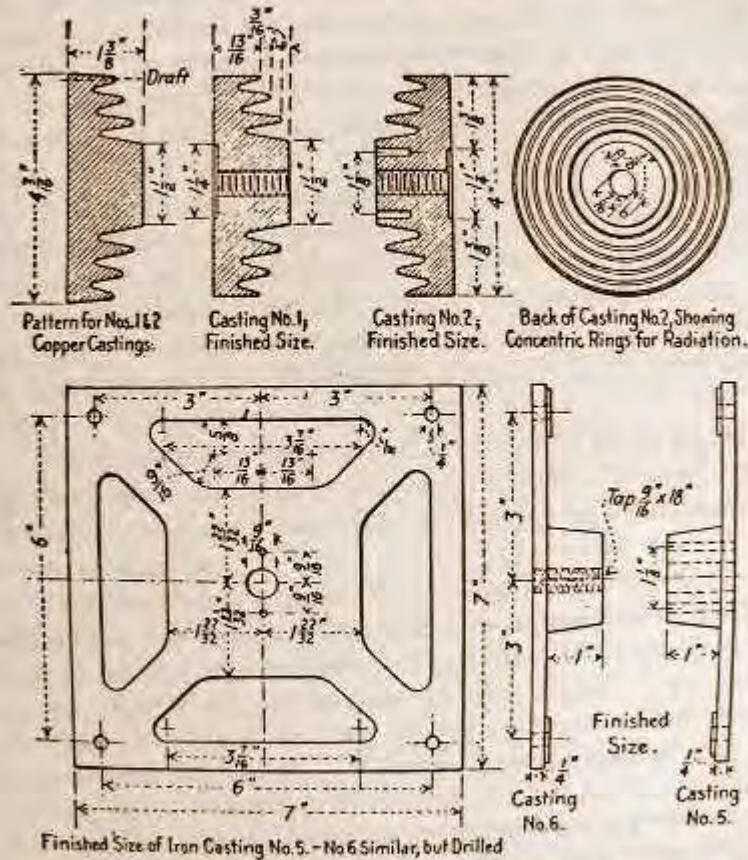

Fig. 60.—Details of electrodes and frame plates

been taken. A slight cut is taken at the end to taper the rod for starting a die on it and the rod is then placed in the chuck with the turned portion projecting. Bringing

up the $\frac{1}{8}$ -18 die with the tailstock face plate against it, the die may be started with accuracy and the thread taken on the spindle. In order to cut the thread quite up to the shoulder of the unturned portion of the spindle, it will be necessary to reverse the die taking the final cut or two with the die on backwards. This completes the work on the spindle for the present.

Before removing the spindle from the chuck, the No. 1 copper casting may be screwed on. The spindle is then removed from the chuck and replaced between centers with the dog as before. The surface of the copper casting may now be faced off with the assurance that it will be truly at right angles with the spindle. The edge of the casting may also be turned. The depression in the center of the casting is cut $\frac{1}{16}$ in. deep and $1\frac{1}{4}$ in. in diameter. This casting finished, it may be removed from the spindle and the No. 2 casting put on. The facing cut is again taken, the depression made, and the edge turned. The entire spindle with the casting is now to be reversed in the lathe, the casting first being pinned to the spindle on which it is, of course, to remain. The drive this time is by means of a stud projecting from the faceplate and engaging a screw in the periphery of the casting; the hole in which the screw is placed is subsequently used for the binding post, to which the flexible cable is attached.

The spindle may now be turned to its finished diameter of $\frac{1}{2}$ in. for a space of $1\frac{3}{8}$ in., and from this point to the end it is finished off to $\frac{1}{8}$ in. ready for threading. The latter operation is accomplished as before by starting the die with the faceplate in the tailstock.

The spindle for the lower portion of the gap casting is, of course, threaded $\frac{1}{8}$ -18 throughout its length. This operation is most easily done by gripping a piece of $\frac{1}{8}$ in. rod in the chuck and threading to the required length before

cutting off. As shown in the detailed drawing, Fig. 3, the length of this spindle is $2\frac{1}{8}$ in.

The frame plates 5 and 6 are iron castings. The pattern is a simple one that may well be cut out on a scroll saw, the boss for spindle and the small elevation in each corner being turned separately and fastened on with brads and glue. The finished size of this casting is shown in Fig. 2. The one pattern serves for both castings, but the machine work on each casting differs slightly from that on the other. As will be noted, the central hole in casting 6 is tapped for the $\frac{1}{4}$ -18 spindle, while that on casting 5 is drilled and reamed to provide a good sliding fit for the plain portion of the spindle 3. The clearance holes for the pins in the upper electrode casting are also indicated in casting 5. A smooth file-cut on the corner bosses finishes the machine work on the frames after all holes have been drilled.

The four corner posts are of fiber rod $\frac{3}{4}$ in. in diameter and faced off accurately to $4\frac{7}{8}$ in. in length. Tapped holes are made in the ends for the $\frac{1}{4}$ -20 screws which fasten the structure together.

The remaining details are obvious in construction. In assembling the gap, the feet and four corner posts are first secured to the lower frame. Then the lower electrode is set up tightly on its spindle in the frame. The upper electrode is placed on the lower and the coiled spring slipped over the spindle. The top frame is next slipped on, making sure that the pins engage the proper holes in the frame. The driving home of the corner screws and screwing on of the insulated adjusting knob completes the assembly, and the builder is ready to see how well he has done his work. The only "snag" is likely to be found in the inaccuracy of the filed bosses on the upper frame. To make a thoroughly good job these should have been faced

off in a lathe at the same time as the central hole was drilled. To do this would require a 10-in. lathe, however, and in view of the admitted restrictions mentioned in the opening paragraphs it was thought best to omit this specification. The facing off and drilling should by all means be done on the faceplate if a sufficiently large lathe is available.

Quenched Gap Transformers.—The transformer for use with a quenched gap is essentially the same as that

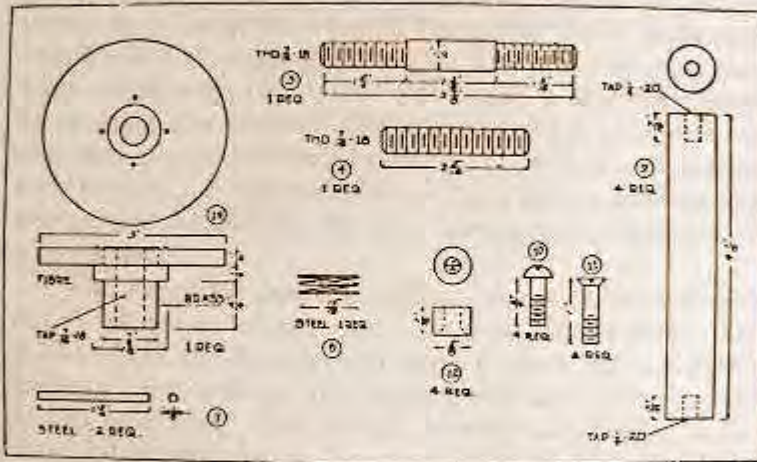

Fig. 61.—Details of the small parts

used with the ordinary open gap. The one possible difference worthy of mention is the secondary potential employed. With the quenched gap, this potential may be considerably lower; this change merely introduces an increase in the number of discharges per second. For certain classes of work, this characteristic is of material advantage, while for others it possesses no particular merit.

The principal advantages to be derived from the low potential secondary are as follows: The discharge from the

high frequency coil is thicker and hotter, although it is not so long; the comparatively low potential secondary is cheaply and easily built and insulation difficulties are lessened materially; for electro-therapeutic work, the quenched gap in connection with the low potential transformer gives a current of very high milli-amperage which is of value in cases where the blood pressure of the body must be reduced by auto-condensation in a short time.

The instrument to be described is of 2 k.w. capacity and it delivers a secondary current at a potential of 2500 volts. The power factor is about 85 per cent. and at full load the primary of the transformer draws 23 amp. from the line on a 110-volt circuit. The winding specified is for 60-cycle circuits but the data for other frequencies may be calculated as described on Page 27. As the construction of transformers has been covered so thoroughly in preceding chapters, no attempt will be made to cover the method of procedure.

The core of the transformer is 3 in. square in cross-section and the core irons are to be provided in two sizes, i. e., 3 by 8 in. and 3 by 12 in. Each leg of the core will require 130 irons to build up the required three inches and accordingly 360 pieces of each size of iron will be required for the core. The core iron weighs approximately 94 lbs. for this transformer. This core is generously proportioned and the instrument may be overloaded to a considerable extent without ill effects as the core is not worked nearly to the point of saturation on a 60-cycle circuit.

The primary winding consists of 152 turns of No. 9 D.C.C. magnet wire wound on a round form. As the winding space on the core is 5 in. the primary coil may be $4\frac{1}{2}$ in. in length overall to provide the necessary $\frac{1}{4}$ in. of space on either side for insulation. The winding may be tapped at the 125th, 135th and 145th turns if it is desired to have a

convenient means of over-loading the instrument. When the full number of turns is in use, the instrument operates at its rated capacity.

The secondary winding consists of 3,454 turns of No. 23 enameled wire wound in two sections. This winding is also done upon a round form, the air-space between winding and core serving to keep them both cool through the medium of the extra radiation surface provided. Each section of the secondary winding may be wound upon oiled paper $1\frac{1}{2}$ in. wide. The winding may be carried out to within $\frac{1}{8}$ in. of either edge of the paper, which makes the actual width of winding $1\frac{1}{4}$ inch. The two secondary sections are separated by a disc of fibre or, preferably, mica-ite sheeting, the edges of which may be bent around to lap over the pieces inserted between the secondary sections and the core. For specific instructions on the winding of a two-section secondary, see the transformer directions in later chapters.

The magnetic leakage tongue may well consist of a bundle of pieces of the core iron cut 3 by 4 inch. The thickness of the bundle will depend upon the condenser capacity used with the transformer and also upon the type of gap employed. The correct amount can readily be determined by experiment, however, after the instrument has been finished and put in operation.

Caution.—The secondary winding of this transformer is of low resistance and it delivers a high potential current that would most likely prove fatal if taken through the body. For this reason, more than ordinary care should be exercised in the handling of the instrument. If one takes the precaution always to make sure that the main switch controlling the primary current is quite open and so located that it cannot by any possibility fall shut while the operator is working with the transformer, no accident can hap-

pen. In the experience of the author, but one serious accident has occurred in connection with this type of apparatus and that was caused through the playful antics of a pet dog. The control switch of the outfit was temporarily mounted upon the floor and the canine came bouncing along just as a connection on the rotary spark gap was being changed; a swish of the dog's tail and the switch came down, turning on the low frequency, high potential current. The shock was sickening but fortunately the body was well insulated from ground as the floor happened to be dry. It is the totally unexpected incidents of this nature that develop into real accidents. The high potential current is something that need not be feared, but it should certainly be respected.

The Condenser.—The oscillation condenser for this type of apparatus may well be built up into sections of .01 mfd. each as described in former chapters. The total capacity required will range from .04 to .08 mfd., depending upon the number of turns in the primary of the oscillation transformer and the type of quenched gap employed. As the potential is low, the condenser is not subjected to the strains that have to be borne by the usual type. The current is relatively large, however, and the plates are likely to heat if the operation is maintained for any great length of time. For all ordinary purposes of demonstration apparatus, the single units connected in parallel to give the desired capacity will answer but if the coil is to be operated for say half an hour steadily at a time, as is the case in certain branches of electro-therapeutics, the series-multiple connection, in which four times the number of units are employed, should be used. For detailed directions covering this condenser, refer to Chapter IV which explains the various methods of connection.

CHAPTER XI.

PHYSICIANS' PORTABLE APPARATUS.

The design of a portable high frequency outfit for the use of physicians has been approached with some diffidence. Such an outfit imposes certain requirements in skill and workmanship that the amateur constructor is not likely to possess.

The portable outfit, to be of practical value, must be compact, light in weight, rugged in construction, and, above all, reliable and very efficient in operation. This means expert workmanship in the construction of the various parts and no little skill and ingenuity in their assembly within a case of small compass. The greater difficulty will be in the placing of the connecting wires and cables. These leads must frequently be placed in locations that are seemingly inaccessible. Should a short circuit occur within the case while the apparatus is in operation, the results might be dangerous. A large measure of the success achieved by electro-therapists has been due to their use of apparatus that could be depended upon to work at the right time and thereby to establish a feeling of confidence on the part of the patient.

For the reason stated above, no attempt will be made to describe the construction of a portable electro-therapeutic outfit of the transformer type. The high tension transformer is difficult of construction for the amateur in the very small and compact design that is necessary in this case. The kicking coil type of outfit lends itself admirably

to the requirements of the practitioner, however, for work at the patient's bedside and such an outfit may readily be constructed by the amateur worker who is the fortunate possessor of a few tools and some ingenuity in their use.

Portable Kicking Coil Outfit.—In Chapter VIII, a very good outfit of this type is described in detail. The specifications call for the various parts of the outfit mounted upon a common base of wood. For the purposes of the physician, the entire outfit may readily be assembled in a wooden cabinet with handle attached, or it may be built into a small leather suitcase. The latter method is, perhaps, to be preferred as the container is more durable.

In building the outfit from the directions given in the chapter referred to, the worker had best employ a mica condenser in lieu of the glass sheets. The mica sheets come in a thickness of about $1/32$ in. and each sheet may safely be split in two as the mica has a higher dielectric value than the glass. The cost of the mica is, of course, much higher than that of the glass but only half as much of the mica is required. The exact number of plates required is dependent partially upon the speed of the interrupter and the worker may well experiment as directed in Chapter VIII to determine exactly the right amount of condenser to use before he proceeds to build the box that is to hold the plates.

The discharger post of the oscillation transformer may prove so long that the apparatus will not go into a case of reasonable size. If this is the case, the post may be cut off an inch above the box in which the coil is mounted, and fitted with a plug and socket connection. The arrangement of the parts will suggest itself to the builder and no specific instructions will be given owing to the fact that the size of the cabinet or suitcase to be used will govern the precise layout of the various instruments. The description of

standard apparatus which follows will serve to offer a few suggestions relative to suitable arrangement.

Standard Electro-Therapeutic Apparatus.—The standard apparatus now on the market has reached a high stage of development and in many cases the physician will do better to buy an outfit outright rather than attempt the construction unless he is exceptionally well supplied with tools and facilities for good work. The portable outfits

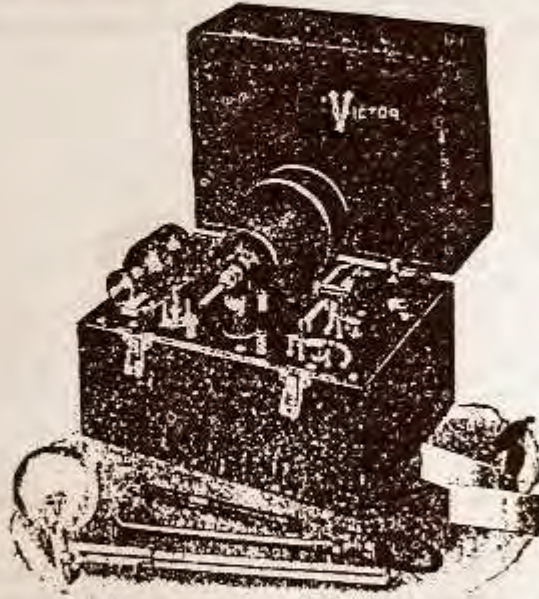

Fig. 62.—Portable transformer outfit designed for vacuum tube treatment work range in price from \$75.00 to \$185.00 and instruments at the latter figure are arranged to operate on either alternating or direct current. With the larger types of these portable outfits, light X-Ray work may be done at the patient's home. This feature is of prime importance where X-ray diagnosis is deemed advisable and where, at the

same time, there is no other reason for moving the patient to the hospital.

In Fig. 62 may be seen a reproduction of a portable outfit that may justly lay claim to many unique features. This is one of the lower-priced outfits but the price cannot be taken as a criterion of its value. The outfit incorporates an exceptionally fine control device which renders it well adapted to the requirements of the general practitioner or the specialist who uses the usual high frequency modalities in his work. The range of the apparatus covers everything but the X-ray and the elimination of this feature in the design is largely responsible for the low price of the outfit.

The outfit is of the transformer type and it operates only on alternating current circuits; for use with direct current, a rotary converter is necessary. The rotary costs about forty dollars and its weight detracts from the portability of the outfit. The main consideration for the prospective purchaser is, therefore, to determine whether the current supply in the places where the outfit is to be used, is alternating or direct. If the latter is found to be prevalent, a modified type of portable outfit selling at the same price would serve the purpose better.

The small transformer outfit described in the preceding paragraph is designed for all classes of vacuum tube, fulguration and diathermic treatments. For fulguration the outfit is ideal as the fine control enables the operator to change from a comparatively cold spark such as is used to produce a dehydrating action, to a hot and caustic spark. The principal feature of the control is found in the use of an interchangeable pair of secondary coils on the oscillation transformer. In addition to this, the "coupling" of the primary and the secondary is variable, which introduces a further refinement of control. One of the secondary units or "inductors" as they are called by the manufacturer, is

wound with comparatively few turns of coarse wire to produce the hot spark for fulguration, while the other coil is wound with a greater number of turns of finer wire to produce the higher voltage necessary for vacuum tube work.

For diathermy where an exceedingly heavy current is made to pass through a localized area of the body, the coil is quite unique as it is capable of delivering a current varying between zero and 2,000 milli-amperes between the diathermic electrodes.

Direct Current Outfits.—Fig. 63 illustrates a treatment

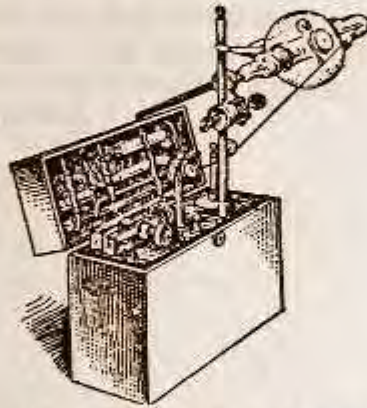

Fig. 63.—Portable kicking coil outfit that will operate on either direct or alternating current

outfit of the kicking coil type that sells for \$75.00. This outfit weighs but thirty pounds, will operate on either direct or alternating current circuits, and combines all of the high frequency modalities with the exception of heavy auto-condensation and X-ray work. True, it will do light general diagnostic work as the potential is sufficient to break down an air gap of four inches which is sufficient to excite the average six-inch X-ray tube of moderate vacuum.

The outfit described is preferable to the transformer

apparatus in the event that nothing but direct current is available in the vicinity. No rotary converter is necessary and if the physician chanced to be in a neighboring town where alternating current is unexpectedly found, the apparatus is equal to the emergency.

For dentists this outfit is exceptionally well adapted. It is excellent for the treatment of diseases of the oral cavity and in addition it will make good radiographs of the jaws with comparatively short exposure.

Large Portable Outfits.—Fig. 64 illustrates an outfit of

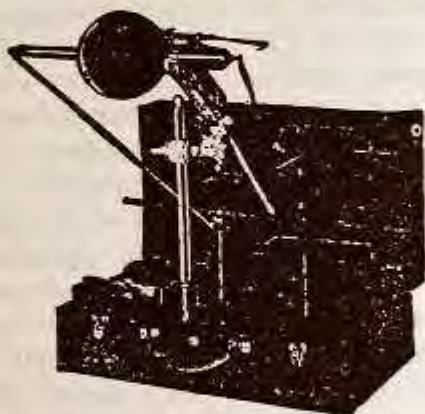

Fig. 64.—Powerful portable outfit comprising both kicking coil and transformer for use on either direct or alternating current circuits

the highest grade which combines the features of portability, reliability, and general utility to a degree not approached by the smaller outfits. The price of this equipment is \$185.00 when arranged for both alternating and direct current use.

This outfit is capable of doing all manner of general high frequency and X-ray work that may come within the requirements of treatment at the patient's bedside. The various modalities can be obtained from the equipment as

follows: Static spark, vacuum electrode, fulguration or convective discharge, high frequency spray or effluve, Oudin, Tesla and D'Arsonval currents, unipolar current, cautery current, ultra-violet lamp (from alternating current circuits only), and currents for auto-conduction and auto-condensation, sufficient for all local treatments. In addition to this, the apparatus is capable of giving very good results in X-ray work of the lighter type such as making radiographs of the extremities, fluoroscopic examinations for diagnosis in cases of fracture, etc.

The outfit combines both a transformer and kicking coil. The former is used on alternating current circuits and the latter on direct. The operation is controlled by means of a few switches and levers and simplicity is a characteristic of the equipment.

CHAPTER XII.

PHYSICIANS' OFFICE EQUIPMENT.

The construction of a powerful and efficient high frequency and X-Ray equipment capable of meeting all the requirements of the general practitioner is well within the reach of the average amateur builder.

True, the apparatus will not be enclosed in a handsome cabinet and the entire outfit will probably be somewhat bulkier than the manufactured article. Furthermore, the cost of the entire apparatus will probably be nearly as great as that of a professional outfit purchased complete. The amateur constructor's principal reason for building his own outfit will probably be the experience he receives and the intimate knowledge of the component parts that he acquires during the process of building.

The design for a 1 k.w. outfit comprising all of the popular high frequency modalities is contemplated. Fig. 65 suggests the assembly of the various units upon a table of conventional design. Of course, all of this apparatus might be arranged within the walls of a cabinet, but for use in the office where the outfit is seldom if ever to be moved, the cabinet has no particular advantages over the simple arrangement shown in the illustration. Furthermore, the assembly on a table results in a most imposing array of instruments all of which are readily accessible for adjustment or repair.

The complete apparatus is divided into two basic groups, one of which is the exciting apparatus comprising

transformer, spark gap and condenser, while the other group embraces the oscillation or high frequency transformers, of which there are three. Of the latter, No. 6, the first instrument on the left in Fig. 65, is a coil of the Oudin type capable of producing a high frequency current of moderate potential for vacuum tube work; high potential current of very high periodicity for producing a spray or effluve; and a current of great intensity, moderate potential and high periodicity for the removal of moles and warts by means of fulguration. The maximum spark length of this coil is about 3 in. The winding is coarse and the coil may therefore be used for high potential auto-condensation work. The variation in frequency and potential is effected by means of an adjustment of the number of primary turns.

The coil shown in the center of the table, Fig. 65, is designed for X-Ray work. This instrument is an oil-immersed oscillation transformer which may be termed a combination of the Oudin and Tesla types since two Oudin coils are placed base to base to form a Tesla coil of sound mechanical construction.

The X-Ray coil produces a thick and very hot 10 in. discharge between the points connected with its terminals. With a suitable high frequency tube, radiographs may be made of any part of the body in a comparatively short space of time.

The oscillation transformer at the right, No. 8 in Fig. 65, is intended for general D'Arsonval treatment and its design is such that the work may be made to cover both auto-condensation and diathermy. The latter is a comparatively new method of treatment which consists in placing a plate of metal on either side of the localized area to be treated and passing a very heavy current of from 800 to 2,000 milli-amperes. The frequency, potential, and intensity of

the current delivered by this transformer may be varied to an astonishing degree by placing the clips attached to the

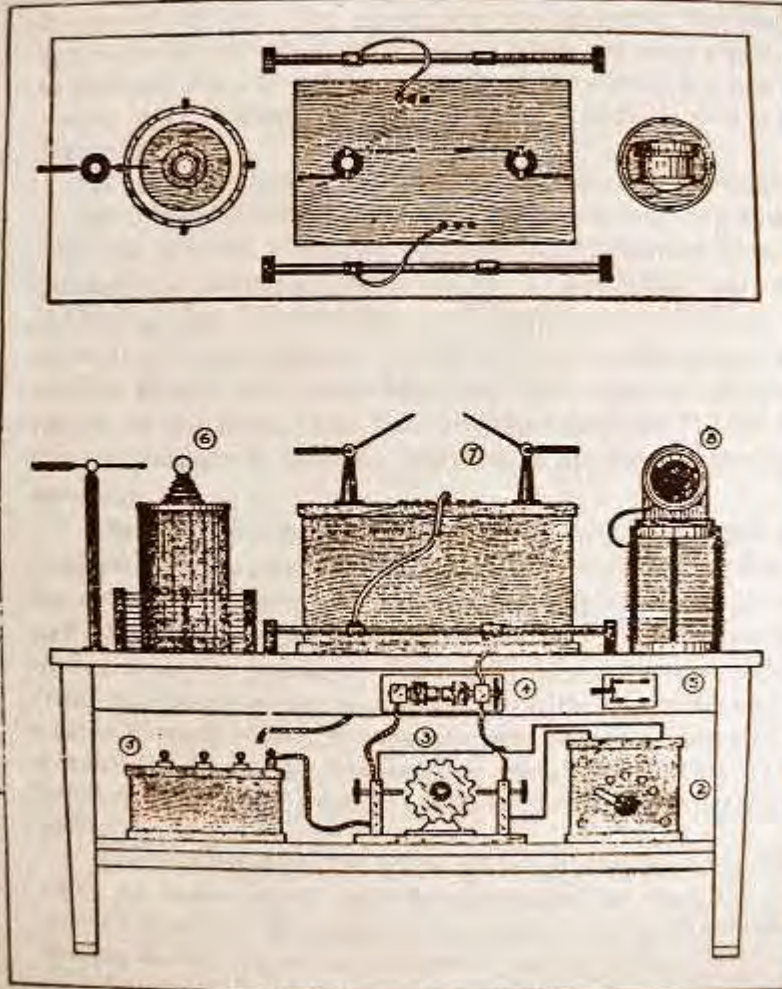

Fig. 65.—Large electro-therapeutic outfit mounted upon a table

flexible connecting cords on different turns of the winding. This wide range of adjustment permits the operator to so attune the apparatus that the circuits through the patient's body and the coil may be brought very closely to resonance.

Reference to Fig. 68 will disclose the wiring diagram for the complete outfit. The reader will note that the leads from the condenser and the spark gap are attached to two copper tubes placed parallel with the X-Ray transformer and supported in insulating pillars secured to the top of the table. From these tubes heavy flexible cables complete the oscillation circuit through the primaries of coils 6, 7, and 8.

The thoughtful reader will, of course, understand that one coil is connected in the circuit at one time; this permits of a concentration of the full output of the exciting apparatus upon the particular coil in use and obviates the necessity of dividing the energy among the several instruments, only one of which is used at one time. Two spark gaps are specified in the assembly, Fig. 65. The gap "4" is of the conventional stationary variety with nickel steel or silver electrodes, while the gap "3" is of the rotary type with zinc stationary and aluminum rotary electrodes respectively. The rotary gap is used for the X-Ray and D'Arsonval coils, while the stationary gap is best adapted for the Oudin Coil, No. 6. The current delivered by the latter coil must be under perfect control and in certain classes of vacuum tube work it is necessary that a delicate and perfectly steady high frequency spark be employed. The stationary gap suggested will enable the operator to adjust his current with such delicacy that the spark may be brought from a velvety spray a quarter of an inch in length to a hot, 3 in., caterpillar discharge simply through an adjustment of the length of gap, variation of primary turns and changes of the current regulator on the low frequency transformer. The rotary gap is intended for long-

continued treatments where the apparatus is working at approximately full power during the entire length of time. While the stationary gap is in use, the disc of the rotary is turned so that the electrodes are opposite the open spaces in the periphery of the disc; when the rotary gap is to be used, the adjustable electrode of the stationary gap is merely opened until the spark prefers to pass by means of the rotary.

A useful accessory to the apparatus is shown mounted on top of the D'Arsonval coil, 8. This is a hot wire meter that will indicate accurately the amount of current passing through the patient's body while the D'Arsonval treatment is being given. The design for a simple hot wire meter is given in the next chapter for the sake of completeness, but in view of the fact that a standard instrument of the type shown in the illustration can be purchased for \$12.00, the amateur builder is scarcely justified in attempting the construction.

The low frequency transformer, 2, which converts the residence lighting current into a high potential one suitable for charging the condenser of the outfit is a standard magnetic leakage instrument with a variation in the number of turns in the primary. The alternating current supply from the house mains is connected with the knife switch shown directly above the transformer and from the switch a cable leads to the low-tension terminals of the transformer. The snap switch controls the rotary spark gap motor.

The condenser is the glass plate type arranged in sections or units which may be connected in multiple one section at a time by means of the single pole knife switches shown on the top of the cabinet (5 in Fig. 65).

For the sake of clarity and simplicity, the construction of the various instruments that enter into the assembly of

the outfit is divided into eight sections, each part bearing an appropriate heading. The numbers preceding each heading correspond with the numbers assigned to the various instruments shown in Fig. 65 which represents the ground covered in the first part of this chapter.

2. *The Magnetic Leakage Transformer.*
3. *The Rotary Spark Gap.*
4. *The Stationary Spark Gap.*
5. *The Oscillation Condenser.*
6. *The Vacuum Tube Treatment Transformer.*
7. *The X-Ray Oscillation Transformer.*
8. *The D'Arsonval Oscillation Transformer.*

Magnetic Leakage Transformer.—This transformer is of 1 k.w. capacity and the data is given for windings suitable for use on 110 and 220 volt alternating current circuit having periodicities of 25, 60, and 125 cycles. This data will be found in Fig. 2 which gives the details of the transformer. The specific instructions for the building of the instrument apply only to the 60 cycle, 110 volt winding as that is the one most commonly used.

The core is a hollow rectangle of laminated silicon steel built up by placing rectangular pieces of the steel with ends overlapping alternately to the right and left as shown in the drawing marked "assembly." Two sizes of core pieces will be needed, namely, $2 \times 5\frac{3}{4}$ in. and $2 \times 6\frac{3}{4}$ in. and 340 pieces of each size will be required. The magnetic leakage tongue shown in the center of the core is a bundle of 90 pieces of silicon steel cut 3 in. \times $3\frac{3}{8}$ in. The silicon steel for the core may be purchased cut to size and ready to assemble, if desired, and this course is the wiser one to pursue if the constructor is not possessed of a gate shear.

The $2 \times 5\frac{3}{4}$ in. pieces of steel are to be divided into two equal piles and each pile assembled with the strips

alternating to such an extent that the overlap is just 2 in. The assembled pieces may be clamped in a vise and tightly bound from end to end with friction tape, releasing the core an inch at a time as the binding proceeds.

The winding is done directly upon the core in the case of both primary and secondary. The illustration suggests how this may be accomplished. Two blocks of wood are prepared with recesses to take the ends of the core strips

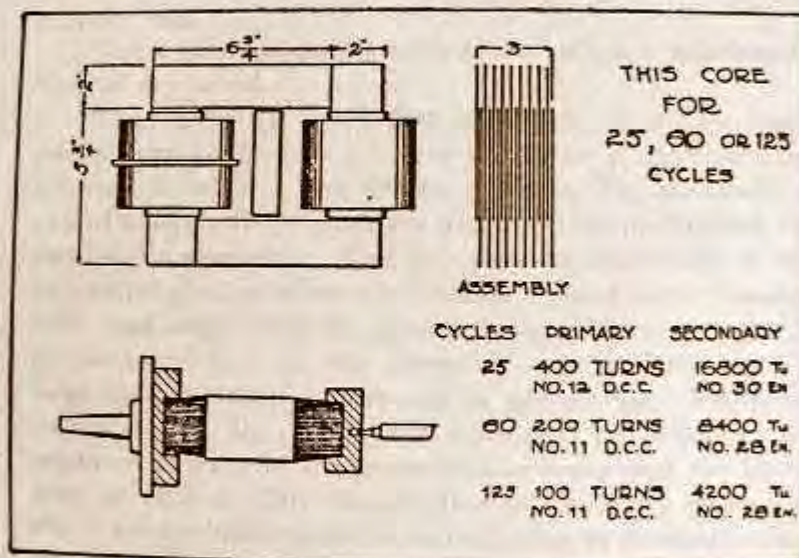

Fig. 66.—Data for the magnetic leakage transformer

in order that the core may be held in the lathe for winding. The primary winding consists of 200 turns in all of No. 11 D.C.C. wire tapped at 110, 140, 170 and 200 turns. The winding is 27 turns per layer and the first layer of wire is wound upon two thicknesses of micanite wrapped over the core. A single turn of micanite is placed between layers of wire to insulate the winding and to keep the latter

uniform. A convenient method of making the taps in the primary is to solder a length of copper ribbon to the proper turn, insulating the ribbon thoroughly with paper where it passes between adjacent turns. To this tap of copper strip, a flexible stranded cable may be soldered and carried to the switch on the outside of the transformer case. When the primary winding is finished it may be given several coats of armalac and permitted to dry.

The secondary is wound in two sections upon the other leg of the core. Each section has 4,200 turns of No. 28 enameled wire which is wound in layers 1 in. wide with layers of oiled paper $1\frac{1}{2}$ in. wide, between. The precise manner in which this winding is done has been covered so thoroughly in other chapters of this book that to reiterate the instructions would be superfluous.

When the windings have been completed, the core is assembled by fitting in the longer core pieces in the spaces left between the projecting ends of the cores containing the windings. This is rather a tedious job, but with the aid of a small hammer judiciously applied, the magnetic circuit may be completed without undue labor. The magnetic leakage tongue is wedged between the yokes of the core by means of wooden strips. The complete transformer is mounted within a wooden case, the dimensions of which have not been given.

The Rotary Spark Gap.—This gap may be of the stock variety sold by many wireless supply houses for use in connection with amateur transmitting sets of from one-half to one k.w. capacity. The design presented in Fig. 65, however, is simple of construction and in use it will be found superior to some of the manufactured articles now on the market.

The rotor is a disc of $\frac{1}{8}$ in. aluminum, 6 in. in diameter, and having 12 semi-circular sections removed from its

periphery, thus leaving a series of 12 teeth, each tooth presenting a surface of $\frac{1}{8} \times \frac{1}{2}$ in. to the stationary electrode mounted on either side. The rotor disc is fitted to a fibre bushing and this bushing is mounted upon the shaft of a small alternating current fan motor, which should have a speed of approximately 1,800 r.p.m.

The stationary electrodes are lengths of $\frac{3}{8}$ in. zinc rod threaded and tipped with large disc of fibre to serve as adjusting knobs to vary the gap between the electrodes and the disc.

The entire apparatus is mounted upon a substantial base of dry wood.

The Stationary Spark Gap.—This gap may be a stock one purchased from a wireless dealer or it may be constructed to order. The design given in Fig. 65 covers a gap of substantial proportions and one that is designed for continuous operation. The gap consists essentially of the two nickel steel or silver electrodes, mounted upon threaded rods, and supported by square brass pillars of suitable proportions. One of the threaded rods is fitted with a large fibre handle for purposes of adjustment. Radiators consisting of discs of brass separated by washers are mounted in back of the electrodes in order that the latter may be cooled. The construction is so clearly shown in the drawings that no further description is deemed necessary.

The Oscillation Condenser.—The condenser comprises four units of .01 mfd. capacity each, so arranged that they may be connected in multiple one at a time by closing the three single pole knife switches mounted on the top of the cabinet. The connections are clearly shown by the diagram in Fig. 68.

Each unit of the condenser is composed of 10 plates of 8 x 10 photographic negative glass coated on both sides

with 6 x 8 in. sheets of tin foil with lugs projecting alternately first on one side and then on the other as the units are assembled. The construction of this type of condenser is thoroughly covered in other chapters of the book.

The Vacuum Tube Oscillation Transformer.—This oscillation transformer is of the Oudin type comprising a secondary of 200 turns of No. 18 annunciator wire in a single layer wound upon a cardboard cylinder 8 in. in diameter and 13 in. long, and a primary helix of 10 turns of edgewise wound copper strip having an inside diameter of $10\frac{3}{4}$ in. The primary turns are supported by rectangular pillars of fibre or hard rubber preferably mounted upon an independent base in order that the complete transformer may be removed from the table without difficulty.

The top turn of the secondary winding is connected with the brass ball surmounting the coil while the bottom turn is connected with a common ground terminal which is mounted upon a copper bar running the entire length of the table. The bottom turn of the primary helix is likewise connected with this ground terminal.

The X-Ray Oscillation Transformer.—This coil is of the oil-immersed type. Fig. 67 shows clearly the method of construction and the reader will note that the transformer is a combination of the Tesla and Oudin types. Two secondary coils are wound upon 6 x 8 in. cylinders of cardboard and the winding is to be of No. 22 D.C.C. wire wound in a single layer until 200 turns are in place on each of the cylinders. The turns are either to be spaced in a lathe or else wound with a coarse thread between, for it is essential that they be separated fully the thickness of a piece of the wire in order that the very high potential between turns may not puncture the insulation. Both secondary coils are, of course, to be wound in the same direc-

tion as one coil is to be a continuation of the other when they are placed end to end.

The two secondaries are secured to the central piece of wood which is fastened to the cover of the case that contains the transformer. The outside ends of the secondary winding are connected with rods leading to the discharge balls of the coil while the inside ends are, of course, connected together, a wire passing through the supporting board for this purpose.

The primary is composed of 8 turns of edgewise wound

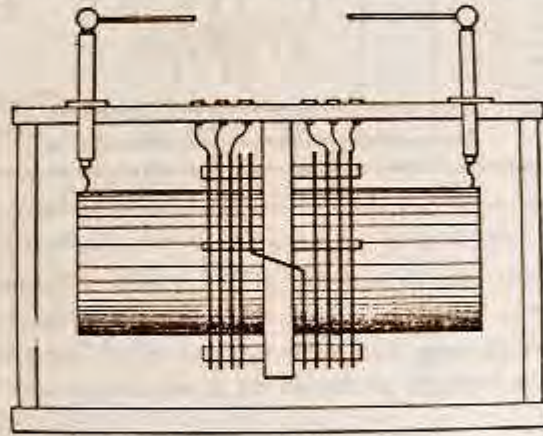

Fig. 67.—Oil-immersed oscillation transformer for X-Ray work

copper strip $7\frac{1}{2}$ in. inside diameter. The helix is divided in the center in order that 4 turns may be placed on either side of the wooden piece upon which the secondary cylinders are mounted. The primary turns are mounted upon slotted fibre supports in the usual manner. A tap consisting of a length of heavy incandescent lamp cord is soldered to each of the 3 outer turns on both sides of the helix and brought to its proper terminal in the cover of the case.

The containing case should be of rather heavy stock

and lined with sheet zinc with corners carefully soldered. The reader will note that when the cover of the case is removed the entire coil comes out with it and there is accordingly no necessity for attempting to make any connections underneath the oil which fills the zinc-lined case.

When the mechanical work on the transformer is finished, the cabinet may be filled nearly full of transformer oil, or if this is not available, double-boiled linseed oil may be employed. The oil should be made very hot before the transformer is lowered into it in order that the air may be expelled.

The essential details of construction are clearly shown in the drawing, Fig. 67. Further discussion is not deemed necessary.

The D'Arsonval Oscillation Transformer.—This is a standard "loose coupled" helix of the wireless type and it may be purchased complete for \$12.00. It is simple of construction, however, and the builder, if he so desires, may purchase merely the edgewise wound copper strip, making the slotted hard rubber supporting posts and the wooden heads in his own work shop. The copper helix is $7\frac{1}{2}$ in. in diameter and the strip may be purchased already wound at 15 cts. per turn. The primary or lower portion of the transformer comprises 8 turns while the secondary or upper portion contains 22 turns. There is no electrical connection between the two, the closed oscillating circuit taking in the primary while the patient's body is connected with the secondary.

Assembly.—The entire lot of apparatus is assembled as shown upon a substantial table fitted with a shelf beneath.

Fig. 68 gives a complete wiring diagram for the entire group of apparatus. The connecting wires should be of heavy stranded cable which may conveniently be made by grouping four or five strands of heavy incandescent lamp

cord together and binding them into a cable with tape or fishline, and soldering the ends into suitable lugs. The variable connections to the turns of the primary coils may be clips of the conventional variety. The drawing suggests

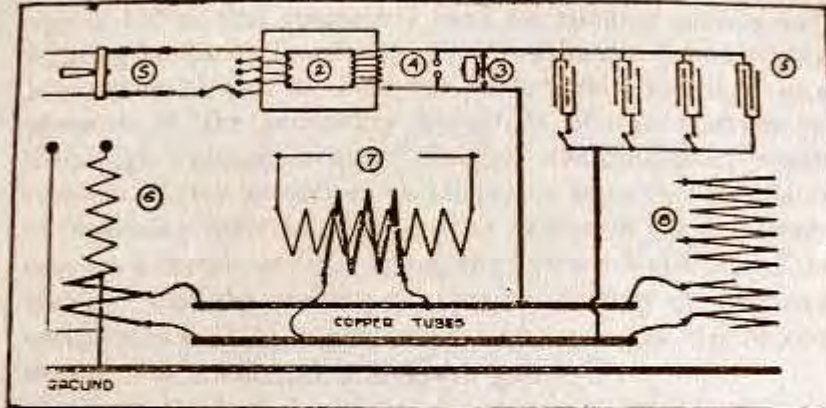

Fig. 68.—Diagram of connection for the entire outfit

a clip of suitable design. The ground connection is absolutely essential and care should be taken to see that the ground terminal is connected with the nearest water pipe whenever the apparatus is to be set in operation.

CHAPTER XIII.

A PHYSICIAN'S OFFICE EQUIPMENT MADE WITH STANDARD MATERIALS.

The materials used in the outfit described in this chapter can be purchased on the open market from the various electrical and supply houses. In this way a very inexpensive and highly efficient outfit can be put together.

The complete set of apparatus is shown in Fig. 69.

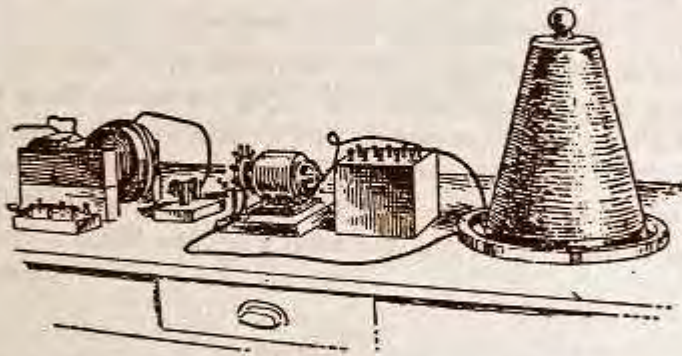

Fig. 69.—Complete, homemade office outfit for physicians' use

This may be said to represent the essentials of the equipment without the trimmings such as controlling devices, electrodes, treatment chair, etc. The apparatus as shown will produce the high frequency current required for auto-condensation, X-Ray or vacuum tube treatment. The containing case or cabinet, controlling switches, etc., will form the subject of the latter part of this chapter.

From left to right in Fig. 69 we see the transformer, stationary spark gap, rotary spark gap, condenser, and oscillation transformer. To define the terms just given we may say that the transformer receives the commercial alternating lighting current from the house mains at a voltage of 110 or that commonly used for running motors and lighting lamps in the house. The transformer converts this low potential current into one of several thousand volts pressure at the secondary terminals of the instrument. This high voltage current "charges" the condenser which consists of two groups of metal plates separated by plates of insulating material. When the charge in the condenser reaches a certain critical value, the current leaps across the electrodes of the spark gap, thereby setting up electrical oscillations or a high frequency current in the circuit connecting the condenser and spark gap.

Now, the high frequency current generated in this circuit is of comparatively low voltage, so we must utilize the principle of the transformer once more to "step up" the voltage to that required for X-Ray and treatment work. To do this we include in the oscillatory circuit a coil or spiral of brass or copper ribbon, having four or five complete turns, each turn separated from its neighbors by insulating material. This forms the "primary" or low-tension side of an oscillation transformer. To produce a very high voltage, high frequency current, we have merely to place within this primary a cylinder or cone of cardboard wound with a single layer of insulated copper wire, connecting the lowermost turn of the cylinder or cone winding with the inside turn of the primary. From this secondary coil we may take a current of perhaps hundreds of thousands of volts, depending upon the number of turns in its winding and upon the relation of its winding to the balance of the circuit.

The transformer and condenser are shown in Fig. 70. The current is applied to the primary at the left and taken from the secondary at the right of the transformer. Primary and secondary are merely coils of very coarse and very fine copper wire, respectively, thoroughly insulated and mounted upon a core or hollow rectangle of silicon steel built up from thin sheets placed one upon the other.

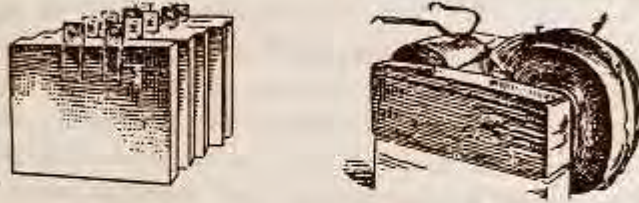

Fig. 70.—The complete transformer and condenser

In Fig. 71 is shown the rotary spark gap and beside it the small stationary gap. The rotary gap is used when the apparatus is working at its full power for the production of a long and powerful spark for use with an X-Ray tube. The smaller gap is used for vacuum-tube treatment work where a small and very mild current, under perfect control, is used.

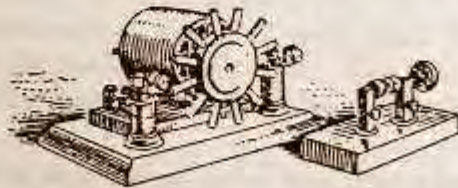

Fig. 71.—The rotary and stationary spark gap

Fig. 72 shows the oscillation transformer which steps up the high frequency current. In Fig. 73 is shown the winding machine, of wood, upon which the cardboard cone is wound.

The oscillation transformer may be purchased, but it is so easily constructed that the builder is advised to attempt it. The first requisite is the cage upon which to do the winding. The construction is obvious. Three discs of

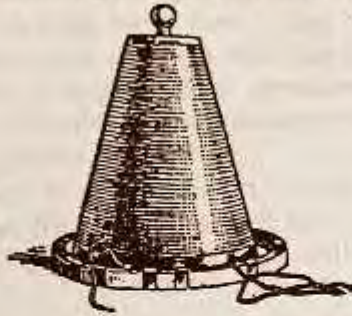

Fig. 72.—The complete oscillation transformer

wood are cut by means of a scroll saw and mounted upon a length of dowel rod which is in turn carried in the simple wooden uprights which form the bearings. Slats of thin wood are then nailed to the discs to form the conical cage.

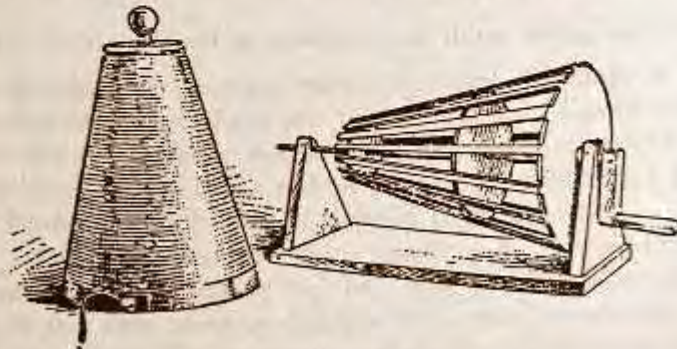

Fig. 73.—The improvised winding machine

In forming the paper cone, red rope insulating paper should be used. This paper is heavy and stiff and it has

excellent insulating properties. A disc of paper of the correct size to form the cone should first be cut. The size of the cone may be varied within reasonable limits in the event that the builder may have some substitute for the winding rig shown. However, it is well to adhere as closely as possible to the dimensions given here. This cone is 4 in. across the top, 12 in. at the base, and 15 in. high at the perpendicular.

Some assistance will be required in rolling the disc of paper into a cone or cornucopia before slipping it upon the form. The final trimming may be done when the cage or form is inside. Glue may be used to hold the edges of the paper together, but we recommend the use of shellac or some other insulating compound as the water in the glue is likely to cause trouble. When the adhesive is thoroughly dry, the seam may be sandpapered smooth and the entire surface of the cone coated with shellac preparatory to winding.

The winding for this size of cone is a single layer of No. 22 double cotton covered magnet wire. The winding is started at the smaller end of the cone, small brads being driven part way into the slats at the end of the cone to prevent the succeeding turns of wire from forcing the first ones off as the winding proceeds. The base of the winding rig should be firmly secured to the work table before starting in.

When a single even layer has been placed, the end of the wire is secured by passing it through the cone and plugging the hole with a toothpick dipped in shellac. Then the entire surface of the winding is thoroughly coated with shellac, care being taken to see that the fluid soaks well into the insulation of the wire. When this coat is *thoroughly dry*, paint a second time and a third. Make

sure that each coat is perfectly bone dry, however, before starting the next.

When the winding is finished, attach a wooden disc to the top of the cone and to this a bed-post ball of brass. Solder the topmost end of the winding to this ball. Solder a piece of flexible lamp cord to the lower end of the winding, and secure in place so that the fine wire will not unwind in use. The oscillation transformer is not complete with the exception of its primary which is so simple as to need very little description.

The primary is merely four turns of brass or copper ribbon, of about No. 26 gauge, and one inch wide, wound into a spiral 15 in. inside diameter, with turns separated

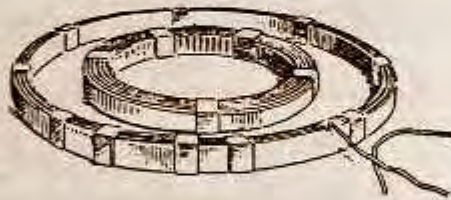

Fig. 74.—The coil used for D'Arsonval and Thermo-Faradic treatments

by a strip of corrugated paper packing. Bindings of tape at frequent points hold the turns together. Connection to the turns is made by means of brass clips formed by bending pieces of the brass ribbon in two and soldering a piece of lamp cord to the top of the clip thus formed.

The coil used for D'Arsonval and Thermo-Faradic treatments is shown in Fig. 74. The smaller ribbon spiral is in this case made to displace the conical secondary as a lower potential is required. In the next article, the construction of a more efficient form of D'Arsonval coil will be described.

This completes the description of the essential parts of the apparatus.

The cost of the apparatus will depend upon the size of the outfit; that is to say, upon the power of the equipment. For instance, for light tube treatment and auto-condensation work in a patient's home, it would be absurd to build an outfit of the power of that shown in our illustrations. One quarter of that power would be sufficient. For the physician's office, however, where an X-Ray picture may have to be made of any part of the body, the larger power is worth while, particularly as such an outfit is not very expensive.

For convenience, we have divided our estimates into groups of $\frac{1}{4}$, $\frac{1}{2}$, and 1 kilowatt, in size. The oscillation transformer may remain the same for all and as its cost is represented chiefly by the builder's time, this item is not listed. Neither is the cabinet to be described. We have listed only the items it will be necessary for the builder to purchase outright before starting construction:

One-quarter Kilowatt:

Transformer, magnetic leakage type	\$ 20.00
Rotary gap	17.50
Condenser, six sections at \$3.00 each.....	18.00
Stationary gap	3.00
Safety condenser	4.50
	<hr/>
	\$ 63.00

One-half Kilowatt:

Transformer, magnetic leakage type.....	\$ 30.00
Rotary gap	17.50
Condenser, five sections at \$4.00.....	20.00
Stationary gap and safety condenser.....	7.50
	<hr/>
	\$ 63.00

One Kilowatt:

Transformer	\$ 60.00
Rotary gap	17.50
Condenser	30.00
Stationary gap and safety condenser.....	7.50

 \$115.00

In these estimates, the transformer is quoted in the unmounted condition. There is no need for paying several dollars for a mahogany cabinet that cannot be used in the

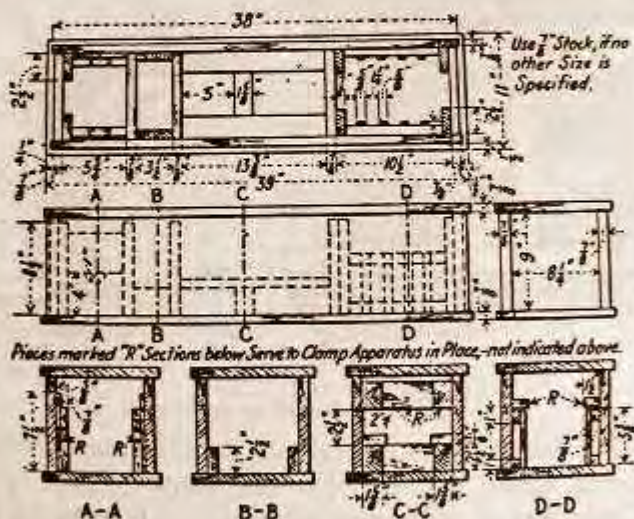

Fig. 75.—Complete details of the cabinet for the outfit

outfit. The condensers are made in two sizes, namely, .0017 mfd. and .002 mfd. The latter are larger and stronger and are therefore used in the large outfits. The rotary gap is the same for all outfits as are also the stationary gap and protective condenser. The latter is necessary to protect the house wiring from danger.

The details of the cabinet are given in Fig. 75. The box may be constructed of mahogany, oak or white wood stained and finished to suit the taste of the builder or to harmonize with the furniture in the office. All of the necessary details of the cabinet are given in the drawing and it is believed that further description will be unnecessary.

Fig. 76 shows the cabinet with cover shut down and the following instruments mounted upon it: operating key, impedance and primary regulators, rotary gap, switch and

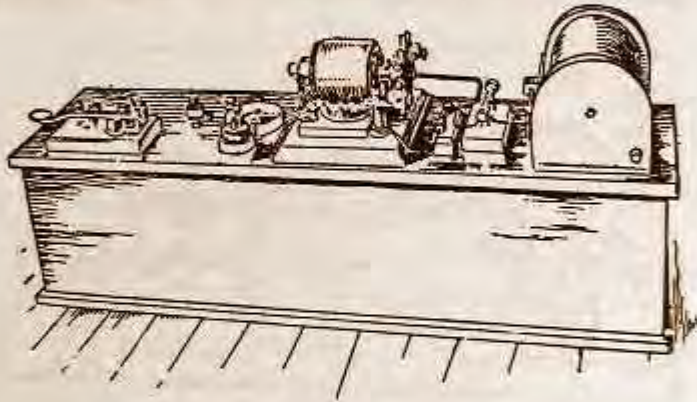

Fig. 76.—The cabinet closed

controlling rheostat, single pole, single throw knife switch, stationary gap, and inductance coil.

Referring to Fig. 77, we have an enlarged view of the left-hand end of the cabinet with impedance coil removed to show method of mounting. This coil consists of a core of iron wire made up into a bundle 2 in. in diameter and $7\frac{1}{2}$ in. long. On this core is placed a single winding consisting of 700 turns of No. 14 D.C.C. wire disposed in even layers and with eight taps taken out of the winding at the last eight layers. These taps, together with the starting and finishing ends of the coil make ten leads in all to be

connected with the contacts of the impedance switch on the cover of the cabinet. The object of this impedance is to reduce the amount of current flowing through the primary of the transformer, when operation at full power is not desired. The impedance, furthermore, makes it possible to produce some very curious and valuable phenomena in connection with the high frequency discharge.

The protective device, consists of two standard condensers of the telephone type, having 2 mfd. capacity each,

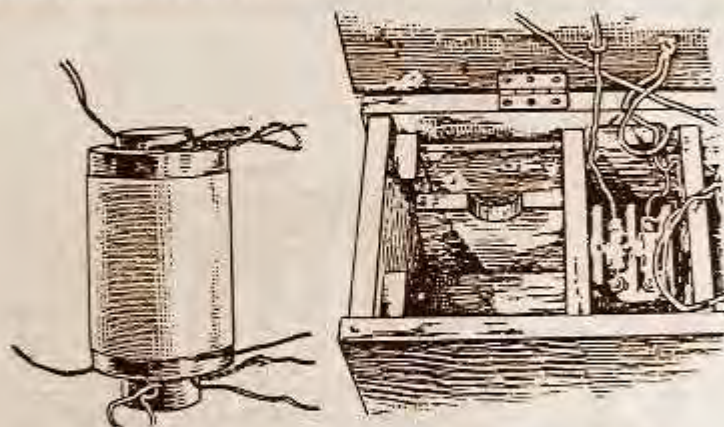

Fig. 77. Method of mounting impedance coil

connected in series, with the outside leads placed across the primary supply wires and the neutral point grounded. This protective device can be purchased in the open market about as cheaply as it can be constructed by the amateur. Its use is absolutely essential to the safety of the apparatus and the house wiring.

The high tension transformer is secured in the cabinet by means of wooden clamping pieces clearly indicated in the drawing. At the end of the first layer of the primary winding, a tap of flexible cable is soldered. This will be of

great service in connection with the impedance in producing such effects as the spray or effluve so desired by many practitioners. The secondary leads from the transformer make connection with the ends of a pair of brass rods which pass through the partition and directly over the condenser. Across these rods is also secured a safety gap comprising two pieces of flat brass strip, so arranged that the space between their ends is not greater than $\frac{1}{8}$ in.

The rods should be insulated from the cabinet and the partition where they pass through the walls by means of

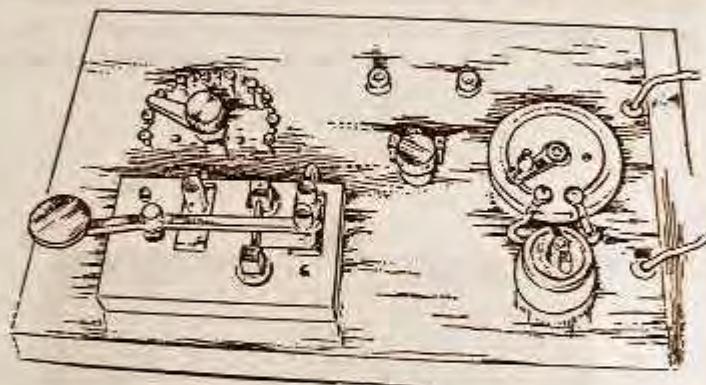

Fig. 78.—Cabinet, showing controlling switches

hard rubber or composition bushings such as are used in incandescent lamp sockets. These rods pass directly through the end of the cabinet where they terminate in binding posts from which the desired leads may be taken.

The mounting for the condenser is so arranged that a free circulation of air is produced between the sections and around them. This is essential if the outfit is to be placed in long continued operation.

The diagram of connections for the entire outfit is given in a separate drawing.

Referring to the illustration Fig. 76, we note that all of the controlling switches and other parts which require adjustment are located on the cover of the cabinet. The standard wireless key at the left is of course placed in series with the transformer primary circuit. Fig 78 is an enlarged view of this end of the cabinet and it shows clearly the arrangements of the controlling switches. Fig. 79 is an enlargement of the right-hand end of the cabinet showing how the rotary and stationary gaps are placed in multiple merely by closing the small knife switch. For all

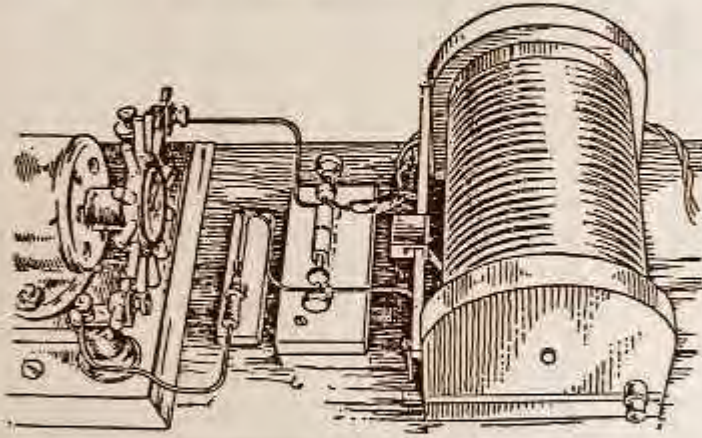

Fig. 79—The cabinet, showing the spark gap

currents at full power or thereabouts the rotary gap is used. For the more delicate currents such as that required for vacuum tube treatment, the stationary gap is employed. By using the full impedance and closing in the stationary gap, a spark a fraction of an inch in length and so mild that it may be directly applied to the bare skin without any pain whatever may be produced. From this we may go to the other extreme by opening out the stationary gap, starting the rotary, and cutting out all impedance. This

will give us the crashing flame shown in some of the illustrations of the discharge.

The inductance is placed in series with the primary of the oscillation transformer or Tesla coil. This inductance consists of 20 turns of No. 10 bare copper wire, wound upon a cardboard drum or cylinder, and with each turn separated from its neighbors by a generous space. This winding may be done by winding two turns of heavy cord in parallel with the wire, removing the cord after the winding is finished. A substantial sliding contact is mounted upon the wooden coil ends, as shown clearly in the illustration Fig. 79. This coil is of great service in obtaining resonance by tuning the oscillation circuit.

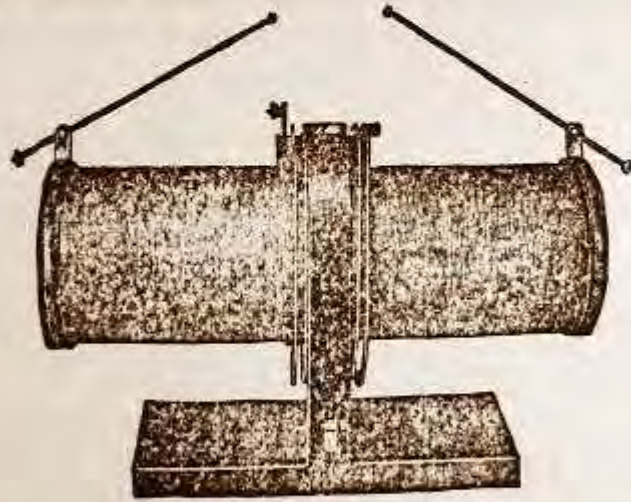

Fig. 80—A standard form of Tesla coil

A form of Tesla coil available in the open market at a reasonable price is illustrated in Fig. 80. The construction is simple and believing our readers might care to build one, we are giving herewith the specifications. The

primary consists of six turns of edgewise wound copper strip 10 3/4 in. inside diameter. This helix is divided into

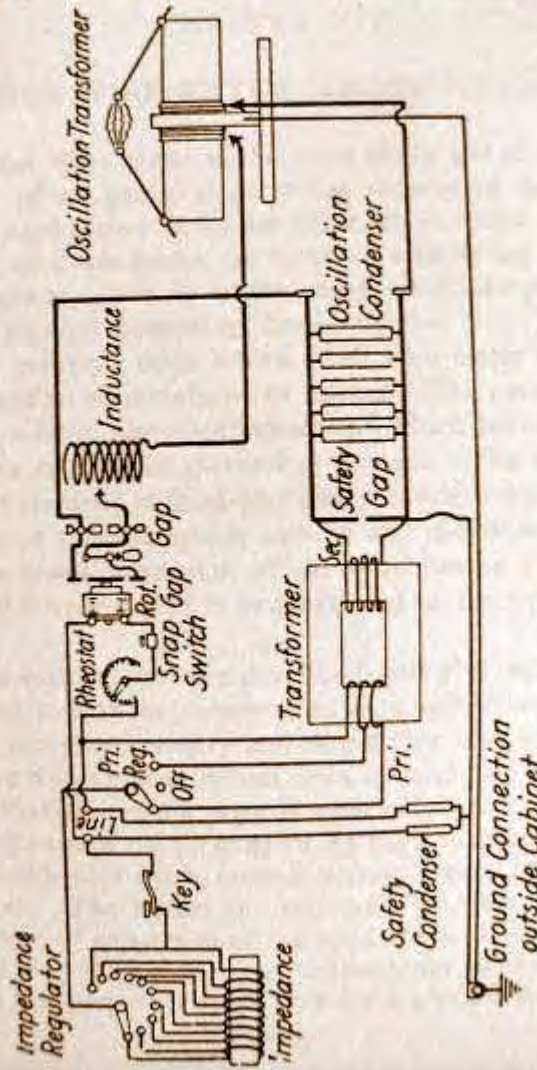

Fig. 81.—The complete wiring diagram for the outfit

two parts of three turns each, connected together in the middle and mounted upon bakelite posts on either side of the central upright piece which is of wood. The secondary consists of two cardboard cylinders wound with a single layer of No. 24 double cotton covered wire, the winding covering the entire length of each cylinder with the exception of an inch at either end. This winding must be very thoroughly filled with shellac, layer after layer being put on, and each one being thoroughly dry before the next is applied. The secondary coils are joined at the center and this point connected with a binding post which leads to the ground wire. The outer ends of the winding lead to the discharge rods shown in the illustration.

A complete wiring diagram for the apparatus described in this chapter is given in Fig. 81.



CHAPTER XIV.

HOT WIRE METER CONSTRUCTION.

A Hot Wire meter is the most easily and cheaply constructed of all practical electrical measuring devices. It may be used either as an ammeter, or in series with a resistance, as a volt-meter, on direct or alternating current of any frequency, and it is the most satisfactory high frequency current measuring device known.

The principle upon which a hot wire meter operates is the expansion of metals when heated. The current passes through a long, fine wire "element," which becomes longer when heated by the traversing current. The one end of this wire element is fixed stationary, while the other end is attached to a lever, which acts as an "indicator." In this way the linear expansion of the wire causes a movement of the indicator which is proportional to the square of the current.

The instrument here described will give very good results and it may be constructed at a minimum cost. Its current carrying capacity and sensitivity may be varied by changing the cross-sectional area or material of the wire used. Platinum alloy wire is generally used on commercial instruments on account of its high melting point, but for experimental work, copper wire will very often answer very well. The higher the resistance and the greater the co-efficient of expansion of the wire, the more sensitive the instrument. The higher the conductivity of the wire, the greater the current it may carry for a given cross-sectional

area. The temperature of the wire should not go too high, because the higher the temperature of the wire above that of the surrounding atmosphere, the greater the loss of heat by radiation, and hence the greater the inaccuracy of the area of the wire must be determined by the current and use for which the instrument is intended. It is best to experiment with several wires to find which is best adapted to the purpose.

The hot wire meter is absolutely "dead-beat," *i. e.*, the pointer does not fluctuate but comes to an absolute rest

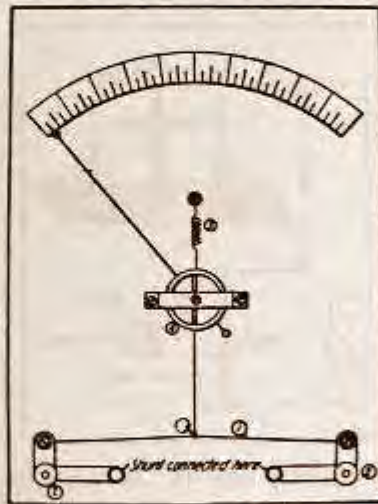

Fig. 32.—Meter with cover removed

as soon as it reaches the extent of its travel. To offset this pronounced advantage, the instrument is slow to record. The hot wire element takes a certain amount of time to assume its final temperature and degree of expansion and the pointer moves slowly over the scale. If a very fine wire is used for the element, the action is hastened and the inability of the fine wire to carry any great amount of cur-

rent be overcome by using a shunt across the meter terminals.

Fig. 82 shows the meter in a plan view while Fig. 83 gives an idea of the movement. The hot wire, 1, is supported between two posts, 2, 2, to which the current is applied. Attached to the center of the hot wire by means of a fine wire hook 3, is a length of silken thread which passes in three turns around the spindle of the pivot 4, which carries the pointer. This spindle is taken from an old alarm clock. From the spindle, the silk passes to the

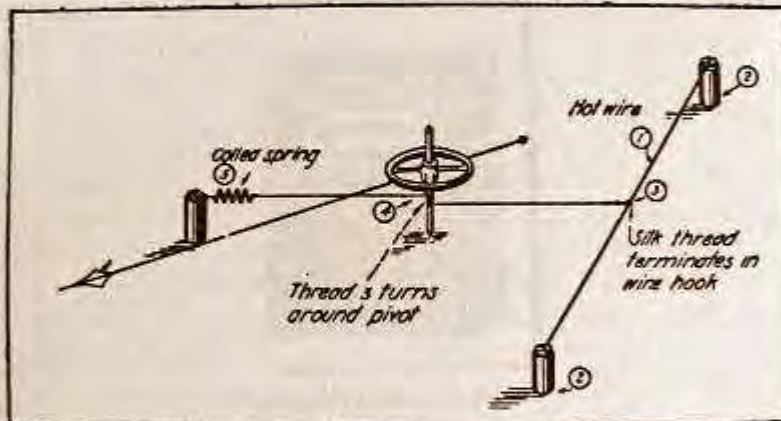

Fig. 83.—Movement of the hot wire meter

end of a coiled spring 5, which is, in turn, held by a low post. When the wire element is heated, it lengthens and permits the silken thread to be drawn forward by the tension of the spring, turning the spindle and moving the pointer over the scale at the same time.

The dimensions given in Fig. 82 are not hard and fast, but they are good in that they produce a meter of tested efficiency and value. Fig. 84 suggests the method of mounting the pivot which carries the pointer. The bridge

is bent up of brass strip and the lower bearing is passed through the base of the meter.

The meter may be covered with a suitable case, preferably of wood if the instrument is to be used on high frequency currents. The mechanism is, of course, covered by the case which has an opening cut in it to show the scale. The latter should be made as the instrument is calibrated. If no standard meter is available for calibration, the values may be placed on the scale with fair accuracy if a bank of 16-candlepower carbon lamps is available on a 110-volt circuit. Each lamp takes approximately $\frac{1}{2}$

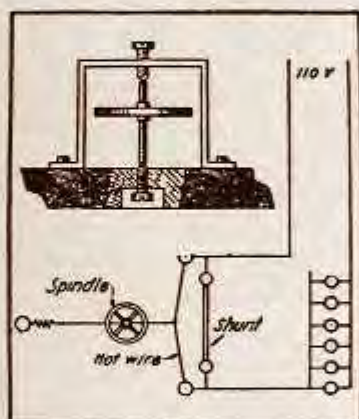

Fig. 84.—The Meter pivot. Showing connections for calibration

amp. and by adding one lamp at a time and marking the scale in half ampere divisions, a fairly correct scale will be the result. Various shunts should be experimented with during the first tests in order that the correct one may be permanently connected across the binding posts of the meter. If the meter is to be read from 0 to 10 amp., a strip of German silver $\frac{3}{8}$ -in. wide and in about No. 28 to 30 gauge will be approximately correct. In testing, turn the current on in gradually increasing amounts until 10 amp.

pass. If the pointer does not describe a full-scale deflection, cut a narrow strip from the shunt and try again. Continue this paring operation until the needle sweeps to the end of the scale when the full amount of current is passing.

For electro-therapeutic purposes, the meter will require no heavy shunt as the current is measured in milli-amperes or thousandths of an ampere. The most practical scale is one reading from 0 to 2000 m.a. (or, 0 to 2 amps.).

The adjustment for zero is effected by turning the



Fig. 85.—The meter in its case

spindle 4, within the coils of silk thread. This is a dainty operation but patience is rewarded by success. The thread will give some trouble owing to its propensity for absorbing moisture and changing its length in consequence. The only remedy is either to seal the case hermetically or, better still, to use a length of the fine tinsel known as "galvanometer suspension." This may be obtained from a maker of high-grade instruments if the builder is fortunate in being near one. The material is exceedingly thin and narrow phosphor bronze strip.

The hot-wire element should be left just a trifle slack.

Under no circumstances should it be taut. Before calibrating the instrument, the wire should be "aged" by heating it to its maximum several times and permitting the pointer to come back fully to the zero point. This will lessen the variation from zero.

CHAPTER XV.

NOTES FOR THE BEGINNER IN ELECTRO-THERAPEUTICS.

This chapter is intended, as its name implies, for the physician who feels a growing interest in the possibilities of electro-therapeutics but who knows very little of the subject. The discussion, therefore, opens with a description of the electrical apparatus in order that the lay reader may understand the reference to the various instruments in the latter portion of the chapter.

The Transformer.—The alternating current taken from the house lighting circuit at perhaps 110 volts is passed through a suitable controlling switch to the primary of the transformer. The function of this device is to change the intensity or voltage of the current from that suitable for lighting lamps to one many hundred times higher. The principle of the transformer has already been discussed in these columns, but for the benefit of the lay reader it may be said to be briefly as follows: When an alternating current is made to flow through a wire, a similar current will be produced in a second wire placed beside the first but having no connection with it. If the two wires be wound into coils and the coils placed side by side, the effect is greatly enhanced, and if a mass of laminated iron be placed within the openings in the coils the effect shows a very marked increase. This property of the alternating current is known as "induction" and the current produced in the

second wire is said to be induced by that in the first. The voltage of the current induced in the second wire is in direct proportion to the ratio between the number of turns of wire in the first and second coils. Therefore, if the first coil contains one hundred turns and the second coil one thousand turns, the voltage induced in the second coil will be ten times that applied to the first. Accordingly, let us assume that in our transformer there are one hundred turns of wire in the first coil or *primary*, as it is called, and thirty-five hundred turns in the second coil or *secondary*. If we impress a voltage of 110 on the primary we shall have a voltage of thirty-five times 110 or 3850 volts at the secondary terminals.

This high voltage makes it necessary to employ highly specialized methods of insulating the windings of the transformer for the tendency of the very high potential current is to leap through the air for a fraction of an inch or to tear its way through even the best of insulators unless they present sufficient resistance to its passage.

We shall next see how this high voltage is applied to the operation of the apparatus and what measures are taken to safeguard the patient from the dangerous current.

We have learned that the alternating current, after entering the apparatus within the instrument case, is transformed or stepped up in voltage to a value perhaps hundreds of times as high as that at which it entered the instrument. This voltage would prove dangerous or fatal under certain circumstances if it were applied to the body of a patient in its existing state. Before it can be used, therefore, it must be converted to a current of very high frequency, *i. e.*, one which changes its direction of flow hundreds of thousands or perhaps even a million times per second. The astonishing characteristic of such a current is that it may be applied to the human body in quantities

which would prove fatal if the current were of the commercial frequency.

The Condenser and Oscillatory Circuit.—Tracing the course of the high potential current as it leaves the secondary of the transformer, we find that it passes into a device called a condenser. This piece of apparatus consists of a number of sheets of tinfoil separated by plates of mica or glass. The foil sheets are supplied with lugs projecting alternately first from one side and then from the other as the foil and mica plates are assembled. The alternate lugs are soldered together on each side and to these joints the wires from the transformer are fastened. Passing from the condenser we find the current flows through the primary of another transformer, but one without an iron core, and finally across a spark gap and back to the condenser.

The condenser acts as a reservoir for the current, which stores up as a charge on the plates until the tension becomes so great that the current leaps across the spark gap in a crashing discharge. This discharge is not composed of a single spark, as appearances would seem to indicate, but it comprises many separate discharges which surge back and forth across the gap with a motion which may be likened to that of a swinging pendulum. When the energy is finally spent the discharge would naturally cease, but during all this time the condenser is again replenishing its supply from the high voltage terminals of the transformer and as soon as one discharge has died away, there is another charge ready to take its place. All of this happens perhaps in the ten thousandth part of a second or less.

The oscillatory discharge of the condenser across the gap sets up a current of very high frequency in the circuit, which includes the primary of a second transformer in it, as previously explained. Obviously, therefore, it is only

necessary to place within this primary a secondary coil having a suitable number of turns of wire in order to obtain a high frequency current of any desired potential. There is no electrical connection between the two in the case of certain forms of apparatus and, owing to the fact that nothing but the current of high frequency would induce another current in the secondary of this transformer—due to the absence of an iron core—there is no danger whatever of the patient receiving a shock of low frequency current from the secondary terminals.

The generation of the high frequency current having been explained, the method of adapting it to the various electrodes and their uses will next be considered.

Disregarding for the moment the effects of the various frequencies upon the body, we may turn our attention to the broad classifications given by the manufacturers of apparatus to the currents produced. The classes are in the main but three: the Tesla or high potential current, the D'Arsonval or medium potential current, and the thermo, or as it is sometimes called, the diathermic current which is of comparatively low voltage as high frequency currents go. In order that the respective uses of the three currents may be the more fully understood, it is proposed to treat them under their proper headings.

The High Potential or Tesla Current.—This current is that taken from the terminal of the post which tops the high frequency apparatus and it is generally applied through a vacuum electrode of glass which is held in an insulated handle of suitable form. The application is quite without pain, and, in fact, without much of any sensation other than gentle warmth, unless the electrode is lifted from the skin in which case the resultant spark is rather painful. Therefore, one of the first points for the operator to impress upon his mind is the fact that the electrode

should never be applied or taken from the patient without the operator placing his own hand upon the glass to divert the current from the patient. The entire success of the electro-therapeutic treatment may be said to rest in the practitioner first of all inspiring confidence in his patient.

The most pronounced physiological effect of the high voltage current is shown in the increase of blood supply to the part under treatment. This results in an improvement in the local nutrition. Other characteristic effects are an increase of heat locally without a rise in the body temperature, a marked increase in excretion and secretion, and a general effect which may be either sedative or stimulating accordingly as the current is higher or lower in frequency.

In at least one particular can the vacuum tube application be said to be the direct opposite to the low voltage or D'Arsonval treatment. The effect of the vacuum tube treatment is to increase the arterial tension when the tube is passed up and down the spine, while the auto-condensation treatment with the D'Arsonval current is exceedingly efficacious in reducing the blood pressure. The pertinent fact here is to note that in cases of arteriosclerosis, the application of the vacuum tube to the spine should never be made. However, where the blood pressure is found to be normal, this treatment is of great advantage in producing a general tonic effect upon the system, particularly if a moderately low frequency is used.

In cases of alopecia and other diseases of the scalp and skin the vacuum tube treatment has been found invaluable. The treatment has received a large amount of publicity under the misnomer of "The Violet Ray," and so far has this misleading advertising been carried that the treatment has frequently been condemned as quack. The violet ray part of the proposition is simply a fascinating and perhaps

mysterious-sounding trade name which was undoubtedly coined as a result of the appearance of the vacuum tube when the current is passing. The interior is filled with a purplish blue light which has led to the conception which, while it makes no claims definitely, leaves the uninitiated under the impression that the treatment is in some way associated with the famous ultra-violet rays of Finsen. The fact of the matter is that even though there were an appreciable amount of ultra-violet light generated within the tube (as is probably the case), the glass walls are practically opaque to the ray and its passage to the patient would be stopped. However, beyond the mere fact that this slight deception has lowered the dignity of the treatment and has made it a name almost as common as that of a patent medicine, the incident need not concern us. The merit of the high frequency current properly applied is now definitely established beyond question, and the physician who first learns its powers and then uses it honestly is sure to derive everlasting satisfaction from the treatment.

The treatment has met with the most encouraging success in the stimulation of the growth of hair on heads not hopelessly bald, and the experience of a number of prominent workers goes to show that even gray hair may be restored to its original color through a perfectly natural process. While success has not come in every case, still the results are so encouraging that the writer believes he is justified in stating that this treatment offers a distinct opportunity to the scalp specialist who is willing to apply himself with the same diligence that he would bestow upon some unfamiliar but promising drug. The effects of the treatment are cumulative, and in stubborn cases patience is necessary, for while the first few treatments do not perhaps have the desired effect, the cumulative characteristics come out after persistent administrations.

CHAPTER XVI.

PLANT CULTURE WITH HIGH TENSION CURRENT.

There appears to be a decided scarcity of data covering the process of plant culture through the agency of electricity. The contributions on the subject have been anything but specific in nature and this is due, in part, to the fact that most of the experimentation has been carried on by private investigators who, for various reasons, do not seem disposed to make public the results of their research. In this country, the greatest progress has probably been made by the agricultural departments of several schools and colleges, and it is to the excellent bulletins from this source that the author is indebted for much of the data that led to some private experimentation. While the present discussion is based upon this experimental work, the author does not wish to pose as an authority on the subject and the remarks herewith are offered in the hope that they may lead to some private research on the part of the readers. An interchange of ideas and experiences is invited and it is felt that such a policy will be conducive to a broader presentation of the subject in later editions of this book.

While the art of electroculture is almost wholly in the experimental stage, still it may be said that the experiments are productive of really practical results and the apparatus necessary for their performance is not expensive, providing the investigator is content to begin on a small scale.

There are several methods by which plant life may be stimulated with the electric current and, in treating of the subject, the author will outline these methods briefly in order that the detailed descriptions of the equipment necessary in each particular case may be made clear. The construction of the apparatus involved will then be covered and it will be optional with the experimenter whether he constructs his apparatus or buys certain parts of it ready-made from manufacturers. The latter course is desirable in many instances as many instruments are rather difficult of construction and can be purchased ready for use almost as cheaply as they can be made in the home workshop.

Electroculture Methods.—The methods by means of which plant life may be stimulated with the electric current may be divided broadly under two headings: one, in which the rays from an electric lamp are permitted to fall upon the area under cultivation, and the other, that in which a high potential current is sent through a network of wires stretched over the plot of ground. This latter method may be further subdivided into two basic headings: One in which a high tension direct or low frequency alternating current is sent through the wires and, the other, that which employs a high potential, high frequency current. The former is simpler and productive of very good results; the latter is the more effective and, in some cases its results have been spectacular.

Merely because the high tension discharge method was productive of the most encouraging results in the personal experience of the author this method will be discussed first of all. It is not claimed that this is the right or even the logical method; it simply "worked" where others failed in the case of one individual investigator who is naturally prejudiced thereby.

The subject under investigation was a bed of lettuce,

10 feet wide by 20 feet long. This was situated across a yard and 50 feet from the companion bed used for purposes of comparison. The two beds were boxed in with lumber and topsoil was taken from the same load for each; in fact, the conditions were as nearly identical as it was possible to make them. Four posts were set up at the electrical bed, in the corners of the plot as shown in Fig. 86. At a distance of 5 feet from the ground, ten wires were spanned from cross-arms attached to the poles. The wires were

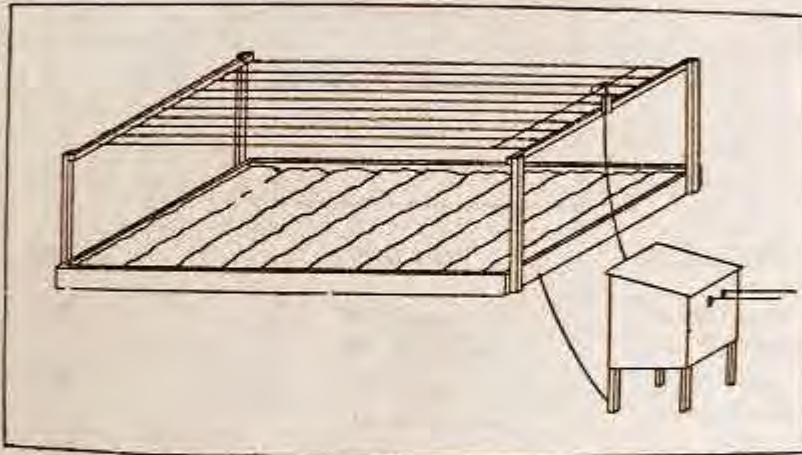

Fig. 86.—Showing span of wires to carry the high tension current over a plot of ground in which plants are to be cultivated

carefully insulated with two porcelain cleats in series at the end of each wire and a common lead connected the span of wires at one end as shown in the illustration. A ground connection is made by means of strips of galvanized iron "chicken wire" buried in the earth beneath the bed. The aerial conductor is brought to a small shed or other shelter arranged near the bed under cultivation and in this shed the high-tension transformer is placed. The power wires from the electric lighting circuit are carried to the trans-

former shed and a switch is conveniently placed both at the shed and at the point where the wires leave the house or pole.

Caution Must Be Observed.—The utmost care must be used to prevent the possibility of persons coming in contact with the span of wire over the bed, or, indeed with either wire leaving the transformer secondary, as the voltage delivered at this point would produce a dangerous shock. To afford a safeguard in this particular, a fence should surround the plot and a contact be arranged at the gate in such manner that when the gate is opened a bell will be caused to ring and this will remind one to turn the current off from the transformer before entering the gate. This device is not difficult to design and in fact it may consist of one of the familiar release pushes such as are used on door jambs.

The transformer used by the author delivered a potential of 10,000 volts and was rated at $\frac{1}{2}$ k.w. The construction was of the closed core variety and the instrument was immersed in oil to assist in cooling as the runs were from 8 to 12 hours daily. Such an instrument can be purchased for a small sum from manufacturers of wireless telegraph apparatus and the experimenter is advised to buy one outright. The necessary details are given, however, so that the ambitious worker may try his hand at the job if his courage is good.

Construction of the Apparatus.—The transformer to be described is generously proportioned in order to provide ample insulation and radiation surface. The constructional details for a transformer to operate on the usual 60-cycle, 110-volt supply are given herewith and in the full-page plate the worker will note that data for 25-cycle and 125-cycle instruments are given also. The windings for 70, 110 and 220 volts are appended as well.

TRANSFORMER DATA

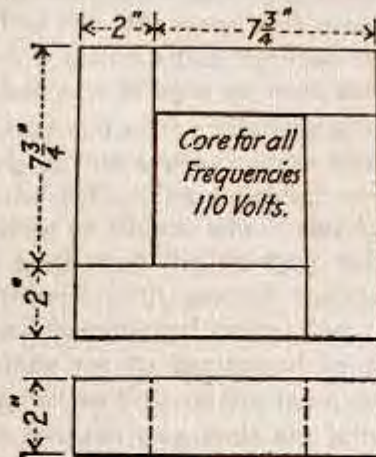

CYCLES	PRIMARY	SECONDARY
25	700 Turns No. 14 D.C.C.	64,000 Turns No. 36 Enam.
60	350 Turns No. 12 D.C.C.	32,000 Turns No. 34 Enam.
125	175 Turns No. 12 D.C.C.	16,000 Turns No. 34 Enam.

From the working drawing, the core is seen to be built up from pieces of sheet iron or silicon steel .014 in. thick and $7\frac{3}{4}$ in. long by 2 in. wide. This is for the 60-cycle transformer. The same general directions apply in the case of the other frequencies, therefore the description will be confined to the one only. In all, 460 pieces will be required. If silicon steel can be obtained from some transformer manufacturer it should by all means be used as it is not expensive and its permeability is very much higher than that of ordinary sheet iron. The core irons are laid

up alternately in piles until each has assumed a thickness of 2 inches, after which end pieces are fitted in the spaces left in the ends of the piles as shown in Fig. 87. Friction tape should be wrapped around the pieces of iron to hold them in place.

The primary coil consists of 350 turns of No. 12 D.C.C. magnet wire wound upon a form which will give the opening in the coil a diameter of 3 inches. The primary may

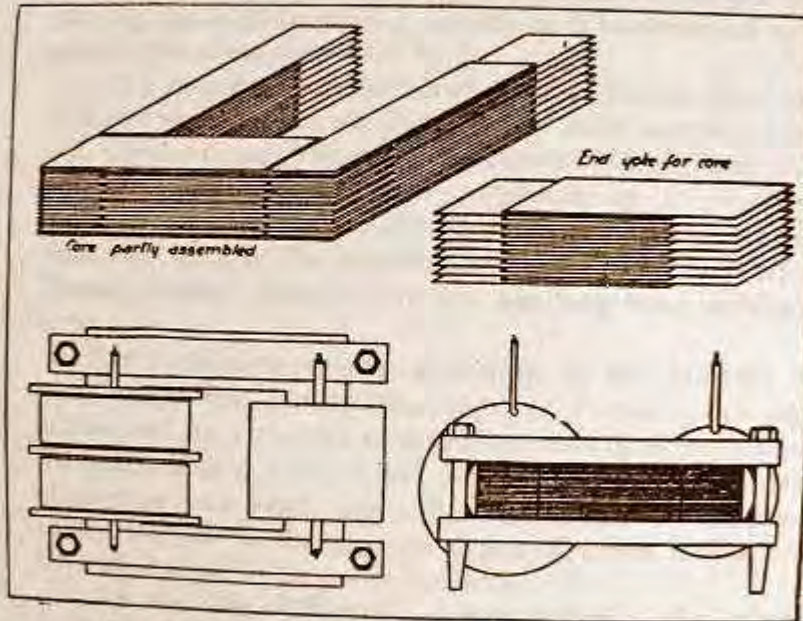

Figs. 87, 88 and 89.—Details of the high potential transformer

be wound to a length of $4\frac{1}{2}$ inches and after it has been removed from the form it should be carefully taped.

The secondary is wound in 2 section, each containing 16,000 turns of No. 34 enameled wire. These sections also have an opening 3 inches in diameter to permit their being placed over one leg of the core. The winding is in 80

layers and has 200 turns to each layer. A strip of oiled paper 2 inches wide separates each layer of wire from its neighbor and as the 200 turns will occupy a space of approximately $1\frac{1}{2}$ inches, it is obvious that a space of $\frac{1}{4}$ inch will be left as a margin on each side of the paper.

The starting end of the winding of each section is soldered to a strip of thin copper ribbon which extends beyond the edge of the coil. The finishing end is likewise connected to a piece of ribbon which should come out on the opposite side to that of the starting end. The final layer of wire is covered with several thicknesses of the oiled paper to afford mechanical protection. The two sections of the secondary are to be wound in such manner as to permit the current to flow in the same direction around the core when the two starting ends are joined together.

The primary and secondary are to be assembled upon the core as shown in the drawing and the secondary sections are insulated from each other and the core by discs of heavy fibre. The remaining core irons may then be placed in position and the core clamped between wooden pieces as the drawing indicates. Pieces of flexible wire are joined to the secondary leads and the entire transformer is then placed in position in a sheet iron container made oil tight. Wires leading from the secondary and from the primary are brought to suitable terminals in the top of the transformer case. The case is then filled with transformer oil until the transformer is well covered. It is believed that the drawings will make the details clear and that further description is unnecessary.

It is, of course, understood that the line wires supplying the alternating current of sixty cycles at 110 volts are connected with the primary terminals while the secondary terminals deliver a current at approximately 10,000 volts to

the span of wires over the plants to be cultivated; that is to say, one secondary wire leads to the overhead wires while the other secondary terminal is connected with the ground.

Actual Results Obtained.—A most interesting report on electroculture experiments was made recently by Mr. T. C. Martin at a convention of electrical men and from this report it may be deduced that, of all the processes by means of which plant life may be stimulated, the one employing the high frequency current as its fundamental principle is the most successful by far.

The experiments mentioned by Mr. Martin were carried out at the Moraine Farm, a few miles south of Dayton, Ohio, and located in the celebrated Miami River Valley. The experiments were promoted by F. M. Tait, formerly president of the National Electric Lamp Association, and were in the immediate charge of Dr. Herbert G. Dorsey, whose work in this line has long been worthy of note.

"In preliminary tests, according to Mr. Martin's report," says the *Philadelphia Inquirer*, "small plots were marked off for exposure to different kinds of electrification. To insure that the soil of one plot was not better than that of another, top earth was collected, mixed and sifted and then was laid to the uniform depth of seven inches over the entire area." To quote further:

"In the soil of Plot No. 1 was buried a wire screen. Over the plot was a network of wire, stretched about 15 inches from the ground. Connecting the network above the ground and the screen below were several wire antennae. The screen was connected to one terminal of a Tesla coil and the network to the other. A transformer stepped a 110-volt alternating current up to 5,000 volts, charging a condenser of tin-foil and glass plates, which dis-

charged through a primary of the coil. About 130 watts were operated for an hour each morning and evening.

"Plot No. 2 was illuminated by a 100-watt tungsten lamp with a ruby bulb. The light was turned on for three hours daily beginning at sundown. Plot No. 3 was illuminated the same way, except that a mercury vapor lamp was used. No. 4 had no artificial stimulation of any kind, being intended as a comparison between electrically excited plant growth and that of natural conditions.

"In Plot No. 5 was buried a wire network connected to the terminal of a 110-volt direct current. The positive terminal was attached to a small sprinkling can with a carbon electrode in its center. The can being filled, the water was subjected to electrolysis for several minutes. The plot was then sprinkled from the can, the theory being that the current might flow from the can, through the streams of water to the soil.

"Plots Nos. 6 and 7 were sub-divided into four individual boxes, two feet square, separated by porcelain insulators and arranged with carbon electrodes at each end. To these electrodes were applied both direct and alternating currents.

"After radish and lettuce seed had been planted and germination had begun, the various methods of electrification were tried with extreme care. The result of the experiments showed that the plants in Plot No. 1 grew in every instance far more rapidly than those in the other beds and more than double the normal growth as shown in the unelectrified bed."

The comparative results obtained with the various processes may be noted in the table which follows, and it is interesting to observe that the high frequency current from the Tesla coil takes the lead from the standpoint of weight

of the edible portion of both radishes and lettuce grown under its influence:

	Plot 1 Tesla Coil	Plot 2 Ruby Light	Plot 3 Mercury Vapor	Plot 4 Nor- mal	Plot 5 Elec. Spkg.
Radishes (ten plants selected at random):					
Total plant weight, grams.....	265.70	137.80	109.50	180.00	78.50
Edible portion, grams.....	139.50	57.40	40.90	79.40	31.00
Edible portion, per cent.....	51.15	41.65	37.34	44.11	39.49
Tops and leaves, grams.....	120.50	75.70	65.90	95.00	41.50
Tops and leaves, per cent.....	43.35	54.92	60.18	52.77	55.66
Roots, grams	9.30	4.70	3.20	5.60	6.00
Roots, per cent.....	3.50	3.43	2.48	3.12	4.85
Lettuce (ten plants selected at random)	67.00	52.60	56.60	46.10	31.30
Edible portion, grams.....	60.70	57.30	50.20	41.80	28.20
Edible portion, per cent.....	90.59	89.92	88.85	90.67	92.10
Roots, grams	6.30	5.30	6.30	4.30	3.10
Roots, per cent.	9.41	10.08	11.15	9.33	7.99

CHAPTER XVII.

HIGH FREQUENCY PLANT CULTURE.

High Frequency Cultivation.—The successful generation of an electric current at high potential and high frequency offers a problem not easy of solution, particularly if this current is to be put to practical use for long-continued periods of time. While there are several methods of producing the current, only one will be considered here as the others are deemed impractical for amateur use.

The generator to be described is designed for hard duty. The complete apparatus comprises a transformer, condenser, spark gap and an oscillation transformer. In the construction of the apparatus, a fairly complete electrical knowledge is essential. The high-voltage transformer must be carefully made and properly insulated, while the accessory apparatus requires not a little mechanical skill for its successful completion. Once constructed, however, the operation of the outfit is a simple matter and quite within reach of the average fruit or vegetable grower.

In order to simplify the explanation, the description of the transformer will be divided into sections, each bearing the appropriate heading.

In accordance with the inevitable policy of this book, the data for transformers of various frequencies are given in the full-page plate appended. The description is for the 60-cycle instrument, and, as the construction of the others is the same, a repetition would be superfluous.

Construction of the Core.—The core is composed of thin sheet iron or preferably silicon steel which may be

obtained from transformer manufacturers. The sheet metal is to be cut into strips according to the specifications given in Fig. 90. The 2 by 6 inch strips are divided into two piles of 130 pieces each and these strips are assembled alternately with the ends overlapping two inches. The $1\frac{1}{2}$ by 6 inch strips are next divided into four piles of twenty each and these are assembled alternately also. These packs are then to be placed above and below the assembled piles as shown in Fig. 92 to break the sharp corners. The piles are then wound tightly with tape and finally covered with several layers of press-board, preparatory to winding the primary and secondary.

Winding the Primary and Secondary.—The primary is wound on one leg of the core and the secondary on the other. The two cores are then joined in a complete magnetic circuit by the end yokes as shown in Fig. 1. The primary winding consists of 125 turns of No. 10 D.C.C. copper magnet wire wound 25 turns per layer and five layers deep. Between each two layers of wire, a turn of press-board should be taken. The first and last turns of wire are held in place with loops of strong tape placed under the winding and drawn tight after the turns are in place. No shellac or other paint is used on the winding as the coils are to be immersed in oil when the transformer is completed.

The secondary winding is in two sections, each containing 4200 turns of No. 28 enameled magnet wire, making 8400 turns in all. The wire is wound in layers about an inch wide and separated by a double thickness of oiled paper between each two layers of wire. The paper should be $1\frac{1}{2}$ inches wide. In Fig. 95 is shown the method of clamping the core leg in the lathe for winding.

Before starting the winding, a strip of thin copper ribbon is cemented to the insulation as shown in Fig. 96 to

provide the connection between the two halves of the secondary. A strip of paper is placed over the ribbon and the winding started after the end of the wire has been soldered to the ribbon. When the first section of the secondary has been completed, the finishing end of the wire is soldered to a piece of ribbon, a few turns of paper taken over the final layer of wire, and the core leg removed from the lathe. The fibre shield which separates the two secondary sections is then slipped in place and the core replaced in gether by means of the copper strip.

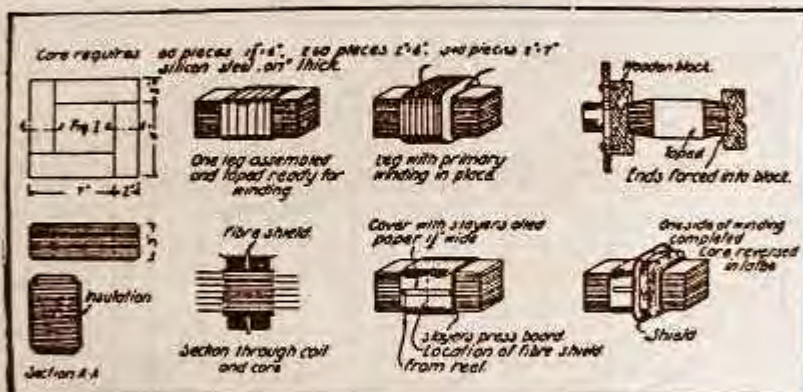

Figs. 90 to 98 inclusive—Details of the magnetic leakage transformer

the reverse direction; that is, the core is turned end-for-end in replacing it to make the blank portion of the core take the place of the wound section. The second half of the winding is then started by soldering the wire to the copper strip as before. Assuming that the lathe is turned always in the same direction, the act of reversing the core insures that the direction of the winding shall be continuous in both sections, with their starting ends connected to-

Assembling and Mounting.—The secondary finished, the two legs containing the windings may be stood on end

and the remaining core strips inter-leaved in place to complete the magnetic circuit.

The reader is referred to Figs. 99 and 100, for the method of mounting the transformer. The core is gripped between clamping strips of hard wood and bolted to a base of the same material. The primary and secondary leads are conducted to upright pillars of hard rubber having a brass rod running through the centre.

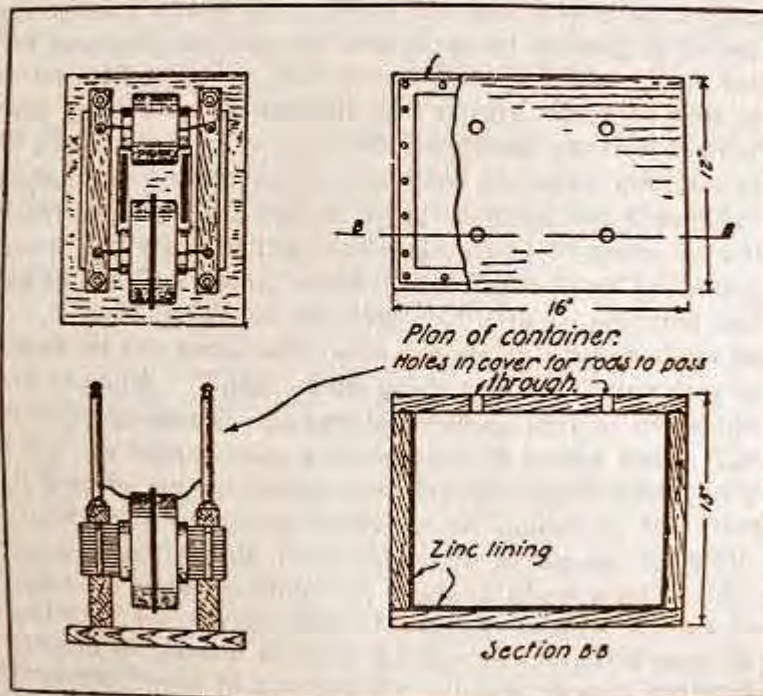

Figs. 99 to 102 inclusive.—The transformer assembled and details of its container

The transformer is placed in a container of wood, lined with zinc as shown in Figs. 101 and 102, which give the

proper dimensions. In the cover of the container are bored four holes to pass the terminal rods.

When the transformer has been placed in the case, the latter is filled with transformer oil to within an inch of the top and the cover fastened down with screws. The addition of substantial handles at the ends of the container completes the work on this portion of the apparatus.

Construction of the Condenser.—In the design of the condenser for our purposes, one or two primary requisites have constantly been borne in mind. The condenser is

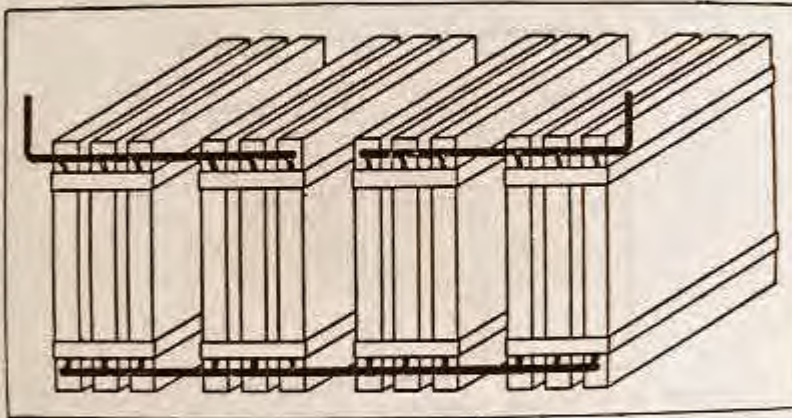

Fig. 103.—The condenser complete showing method of connection

subjected to practically continuous use for several hours at a time and it is obviously essential that ample radiation surface be provided in order that the plates may remain cool. Coupled with this highly important point may be mentioned the importance of eliminating all corona or brush leakage around the edges of the tinfoil plates. These requirements are ordinarily met with in an oil immersed condenser, but the latter, to be efficient, should employ only oil as its dielectric and such a condenser presents

constructional difficulties not easily conquered by the amateur workman. As the next best solution of the problem, the design for a glass plate condenser of large heat-radiating surface and of substantial construction is offered in this chapter.

For its construction the condenser will require 120 plates of glass 8 by 10 inches of the kind used for photographic negatives. Old plates of the latter sort may be purchased cheaply from nearly any photographer and they serve the purpose admirably. The first step is to remove the emulsion coating on each plate by soaking it in hot water and scraping with a putty knife. The plates are then to be dried thoroughly and divided into four piles of 30 plates each. The complete condenser consists of four units, of 30 plates each, connected in series multiple as shown in Fig. 103, and in order to make the description clearer the steps in the construction will be given for but one of the four units, which are alike in every particular.

A good grade of varnish gold size is procured and placed on the work-table with a good soft brush about an inch in width. Tinfoil of the grade used by florists may be procured in pound packages containing four or five strips of foil six inches wide and perhaps 48 inches long. The foil is to be cut up into pieces 6 by 8 inches in size, neatly flattened and separated ready to be applied to the glass plates, which should be arranged in a pile on the table. A plate is removed from the pile and given a quick, thin coating of the varnish (which dries in twenty minutes in the open air) and a sheet of foil immediately laid upon it, care being taken to see that the foil is accurately centered on the plate. The foil may be forced into smooth and close contact with the glass with the aid of a wad of cotton placed within a piece of soft cloth to make a sort of pounce or dauber. Starting at the center of the foil sheet and

carrying the rubbing process toward the edges with a circular motion, the workman will be able to force the foil into what is practically absolute contact with the glass, and at the same time cause the surplus of varnish to exude from the edges.

The plate is then turned and coated on the other side in exactly the same manner; the process is repeated with each of the thirty plates in each of the four units until the 120 plates have been coated. The lot may then be laid aside to dry in a warm room for several days. When this has been accomplished, each plate is to have its edges

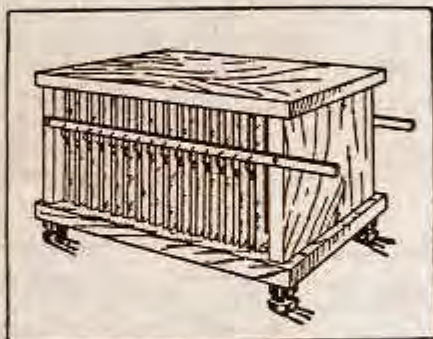

Fig. 104.—One section of condenser mounted in its case

dipped into melted beeswax to a depth of $1\frac{1}{2}$ inches in order that the edge of the tinfoil on both sides may be thoroughly coated with the wax. This will quite prevent the corona or brush losses so frequently noted with glass plate condensers.

The rack in which the plates are to be mounted may next claim our attention. Its construction may be noted in Fig. 104, which gives a perspective view of the complete unit. The reader will see that the support comprises a baseboard and cover of wood separated by two end pieces. The plates slide in grooves formed by $\frac{1}{2}$ -inch square strips

of wood nailed to the base and cover. A bar of $\frac{1}{8}$ -inch by 1 inch copper runs across from one end piece to the other on either side and affords a means of connecting the many plates in multiple. This connection is accomplished by means of the special contact leads shown in Fig. 105. These leads are merely pieces of lamp cord tipped at one end with a lug and at the other with a contact made from a piece of spring brass ribbon bent into the shape shown in the drawing. The object of the contact is to establish



Fig. 105.—Spring connector and cord for condenser

connection between both plates of tinfoil when the spring is inserted.

In making the connections to the bars on either side, the contacts are alternated in order that the plates may all be in multiple. That is, referring to Fig. 104, in starting to insert the contacts, on the one side the first contact spring is inserted between the first and second plate; on the other side the contact would be between the second and third; returning to the nearer side, the second contact is inserted between the third and fourth plates, and so on until all have been put in place. The contact with the first and last coatings are of course made by inserting the clip between the tinfoil and the wooden end piece, placing a small sheet

of glass between the spring and the wood to prevent the metal coming into contact with the wood.

When the four units have been made as described, they are to be connected up as shown in Fig. 103, the connecting leads being strips of copper ribbon. The setting up will receive due attention when the rest of the apparatus has been described.

Construction of the Spark Gap.—Perhaps no one portion of the high frequency apparatus is more likely to give trouble and to require frequent attention than is the spark

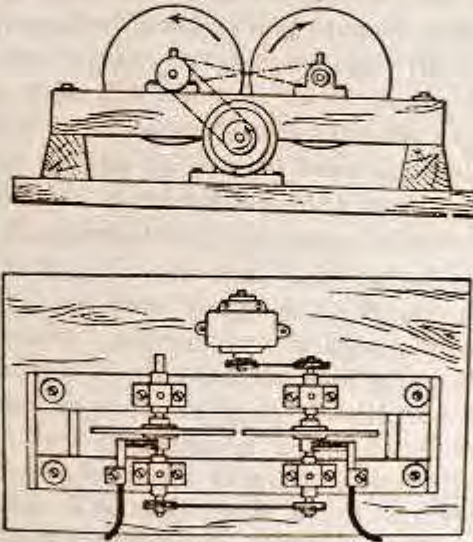

Fig. 106.—Self-cooling spark gap

gap across which the condenser discharges. The discharge is accompanied by heating effects which are in themselves troublesome, and while the ordinary stationary form of gap may give satisfactory service for a time at least, still its successful operation is hindered as the sparking surfaces become heated and pitted. The gap to be described has

proved its value in actual practice and, while it may appear to be unnecessarily complex in design, still the many points of advantage are only brought out through the construction of a substantial and more or less massive affair.

With reference to the side elevation and plan views

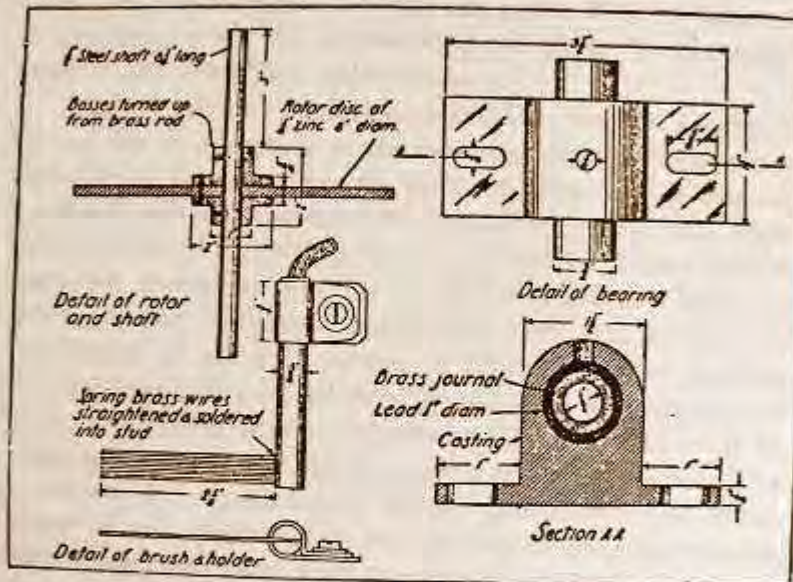

Fig. 107.—Details of the spark gap

arranged to rotate in opposite directions at a fairly rapid rate of speed. The rotation serves the double purpose of always presenting a fresh sparking surface, and therefore a cool one, to the point of discharge, and in establishing a strong current of air directly upward and between the sparking surfaces, due to the surface friction of the periphery of the discs. The effect of this current of air is to assist in the wiping out of any arc which may form during the discharge.

The discs are mounted upon a substantial framework

and base of dry wood which has been painted with or preferably boiled in paraffin wax. The discs are mounted upon shafts of $\frac{1}{2}$ -inch steel and secured to the latter by means of brass bosses turned up and drilled to a snug fit on the shaft. When the final assembling has been done the bosses are pinned to the shaft and to the disc, thus insuring the permanency of the construction. The final operation is to take a finishing cut off the periphery of each disc with the shaft held between centers in the lathe.

The details of the bearings are given in the enlarged drawings, Fig. 107. The reader will note that the bearing proper is a journal of brass tubing reamed to fit the shaft nicely. The bearing support is a casting with a hole cored through it to take the journal. Slots in the feet of the bearings permit the distance between the discs to be varied.

When the various parts have been finished, the bearings are located on the framework as shown in the plan drawing and the journals slipped over the shafts. A piece of cardboard is then forced over each end of each journal after the latter has been propped up inside the bearing with bits of wood. Melted lead is then poured into the opening at the top of the bearing and when cold it will hold the journals in perfect alignment with the shaft. The bearings may then be removed and a small hole drilled down through the lead and brass to afford a passage for oil to the shaft. The addition of an oil cup stuffed with a wick completes the bearings, which may be replaced on the frame.

The shafts are belted together with rubber belting crossed to make the discs turn in opposite directions. The driving is accomplished by means of an electric motor belted to a pulley on one shaft.

The current is conducted to the discs through wire or gauze brushes bearing upon the smooth bosses, as shown

in the plan view in Fig. 106. The details of the brush holder are to be seen in Fig. 107.

The discs should rotate freely and quietly when the motor is started. If the oil cups are properly fitted, the gap should be capable of an all-day run without trouble developing. The adjustment of the gap will be considered in due time, when the instructions are given for the operation of the completed apparatus.

The Oscillation Transformer.—The reader has been told of the construction of the transformer which steps the commercial lighting current up to a potential of several thousand volts, the condenser which stores up this high voltage, and the spark gap or discharger across which leaps the stored-up current in the condenser. The discharge of the condenser across the gap sets up electric oscillations or, as it is termed, a high frequency current. In order that this current may be rendered suitable for the purposes of electro-culture, however, its potential must be raised to a very much higher degree and the object will be to explain the construction of the special type of transformer or coil employed in the process of stepping up the already high potential, high frequency current.

The high frequency transformer differs from the type used for the conversion of low frequency or commercial currents in that it has no core of iron and the turns in its primary and secondary are numbered in tens and hundreds, respectively, instead of in hundreds and thousands, as is the case with the transformer used for lighting and power work. Furthermore, on account of the extremely high potentials induced in the oscillation transformer, the insulation problem must be treated in a somewhat radical manner. This problem is not, however, so difficult of solution as it might seem. The coil may be of generous propor-

tions, since close coupling of the primary and secondary winding is not essential, and the permissible air space affords a most effective insulator. While the efficiency of oil insulation in cases similar to the present one is not questioned for one moment, still the air insulation, if properly carried out, offers exceptional advantages over all other forms wherein the windings are hidden from view and are inaccessible. The latter method has accordingly been selected.

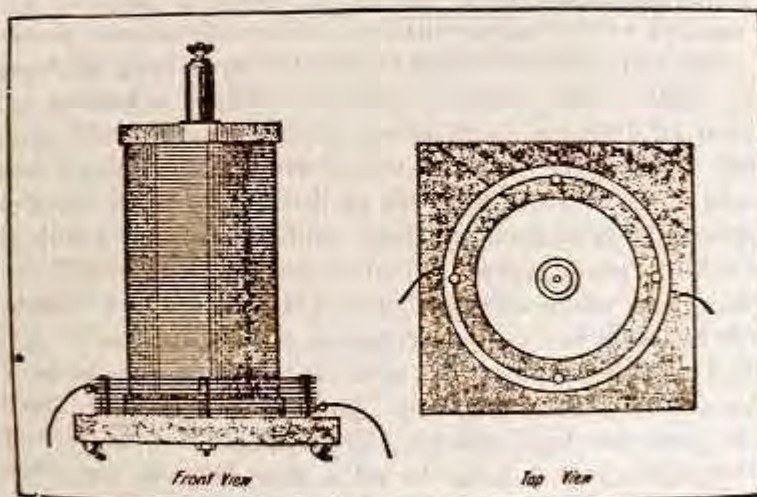

Fig. 108.—The oscillation transformer complete

The transformer consists essentially of a primary winding of eight turns of copper strip placed at the base of a cylinder around which is wound the secondary of 300 turns of No. 30 D.C.C. copper magnet wire in a single layer. The starting point of the primary, as well as that of the secondary, is connected to a stud of metal which passes through the base of the instrument for ground connection. The primary of the coil is connected in the circuit of the

condenser and spark gap in order that the oscillations may pass through the copper strip and thus induce a high frequency current of higher voltage in the secondary winding. The general appearance of the completed coil is shown in the illustrations, Fig. 108, and in Fig. 109 the reader will find details of the parts from which it is constructed, together with the dimensions of the various pieces.

The secondary cylinder is of cardboard and made expressly for the purpose. In designing the coil, the writer

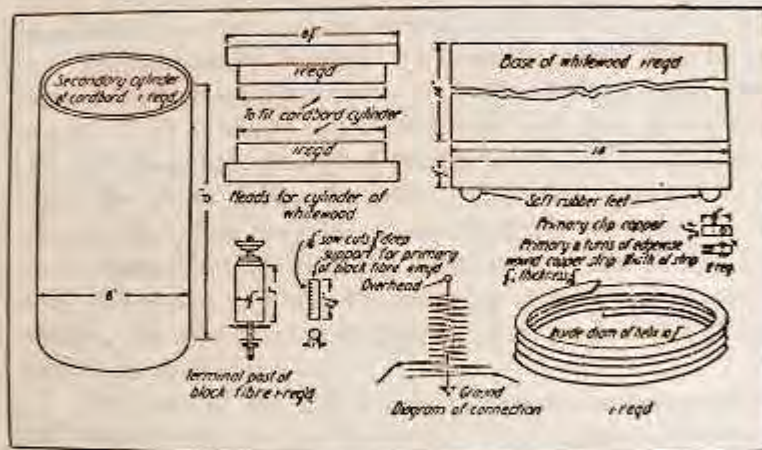

Fig. 109.—Details of the oscillation transformer

has purposely chosen, wherever practicable, dimensions which correspond with the standard sizes of the parts now obtainable through electrical manufacturers. Accordingly, the cylinder has been made eight inches in diameter and 13 inches long. The wall is about one-fourth inch thick. Into each end of the cardboard cylinder is fitted tightly a head turned up from whitewood and soaked for an hour in melted paraffin. The heads are drilled for the terminal post and the brass stud, respectively. The details of the

terminal are given in Fig. 109 but the stud has been omitted, since its construction is obvious. The next operation is to treat the cardboard cylinder to three coats of shellac, making certain that each coat is bone-dry before applying the next and baking the cylinder after each coat in a moderately warm oven.

With the third coat of shellac quite dry, the cylinder may be mounted in the lathe between centers, a slender screw driven into the wooden head and catching a slot in the faceplate to afford a means of driving. The lathe should then be speeded up and the surface of the cylinder carefully gone over with the finest sandpaper to remove the inevitable irregularities caused by particles of dust and dirt. On no account must emery paper or cloth be used and the lathe bed must be scrupulously clean while the cylinder is being handled, as the least trace of metal chip or dust under the winding would be fatal to good results.

The surface of the cylinder having been carefully smoothed over, the lathe may be prepared for the winding. The gears are set to cut 24 threads per inch and the winding of No. 30 D.C.C. wire is started one-fourth inch from the end. In starting, the wire should be passed through a small hole in the cylinder and the hole immediately plugged with a bit of wood covered with wet shellac. This will prevent the winding from coming loose during subsequent handling. The lathe should be turned slowly and backward, and the wire fed through a guide held in the tool post. When the finishing turn, the 300th, is in place, the final end of wire may be passed through the cylinder and secured as was the starting end.

While the coil is still in the lathe, the winding should be coated with shellac applied in a thick solution and with a soft brush, the greatest of care being taken to see that the fluid soaks well into the turns and between them and

also that no air bubbles or particles of dirt are permitted to remain. When the first coat has dried for an hour or more, the cylinder may be carefully removed and placed in the oven, wherein the temperature should not be over 150 degrees F. The baking may continue for a few hours and the second coat applied after the coil has been put back in the lathe. The builder is strongly advised to do all of the painting in the lathe, as the examination and turning of the cylinder is greatly facilitated thereby. The third coat may be the final one and it should be dried as thoroughly as the first and second.

The secondary finished, the wooden heads may be removed and connection made with the terminal and base studs. This is easily accomplished if the ends of the wire are left long and passed through the holes in the heads with the studs fitting loosely. When the heads are replaced, the wires may be drawn taut and the nuts of the studs turned up to grip the bare wire. The heads may then be secured in place by plugging with wood dipped in shellac, the small holes drilled around both top and bottom of the cylinder.

The base of the instrument is simple in construction, as is readily seen in the drawing. The method of supporting the primary strip, as well as the nature of the latter, will, however, bear some explanation. The copper strip is $\frac{1}{2}$ -inch wide and $\frac{1}{8}$ -inch thick and is wound edgewise into a helix having an internal diameter of $10\frac{3}{4}$ inches. This helix material is also to be obtained in the size given and it can be purchased far more cheaply than it can be formed up by the amateur workman unless he has the necessary equipment for the bending operation. As this device is quite complicated, the space necessary for its description will not be taken here. The problem is to bend the thin strip edgewise and prevent it from buckling.

Assuming that the builder has procured the helix material, eight complete turns of which are required, the attention may be directed to the posts which support the helix on the base and at the lower end of the secondary cylinder. From the detailed drawing in Fig. 109 the reader will note that four posts of black fibre rod, $2\frac{1}{4}$ inches high and one inch in diameter, are given a series of saw cuts to a depth of three-eighth inch. Eight cuts will be required in each post to take the eight turns of primary strip. The cuts may be made with two blades of a hacksaw placed side by side to give the required thickness or, what is by far the better method, the cuts may be taken in a milling machine if one is available. The posts are located on the baseboard and secured with short machine screws tapped into the fibre. Care should be taken to see that the screws do not pass into the posts beyond the bottom turn of the primary.

The assembly of the parts is clearly shown in Fig. 110 and it is believed that no further comment is necessary other than to say that the bottom turn of the primary is connected with the ground stud, as shown in the diagram of connections.

Installation of the Apparatus.—We have seen how the various instruments comprising the high frequency current generator are built in order that we may have available a steady supply of high potential current, oscillating at a frequency of approximately 100,000 cycles per second. It is this high potential, high frequency current that we shall employ in the electrification of our plot of ground, and the object of the present article is to point out how the various instruments of the outfit are connected and combined to produce the current.

The entire outfit should be housed in a perfectly weather-tight shed. The construction of the building may

be comparatively crude, if the precaution is taken to carefully seal all cracks and crevices, not only in the walls, but around the door as well. In rainy weather, or even when the humidity of the air is high, the inside of the shed should be kept dry and warm by means of a small oil stove. Dampness is positively fatal to the successful operation of the apparatus if it is permitted to strike in for any length of time.

The shed should contain a substantial wooden table along the rear wall facing the door, and upon this table the apparatus is arranged in the order shown in Fig. 110.

The floor of the shed should be at least one foot above ground and an open air space should be left beneath in order to frustrate dampness so far as is possible. A simple and good construction is to build the shed around four substantial corner posts, starting the walls a foot above the ground. The roof should have a generous slant to shed the rain.

With reference to the first drawing, the apparatus is arranged in the following order, left to right: Transformer, spark gap, condenser and oscillation transformer. Upon the wall to the left is secured the main switch, which should incorporate a cut-out fitted with 15 ampere plug fuses. To this switch from the outside of the shed, lead the line wires, which are to be supplied with a 110-volt, 60-cycle alternating current, preferably from the local central station.

Beside the main switch, the switch for the spark gap motor should be located. The primary terminals of the transformer are to be connected with the main switch, as shown in the wiring diagram below, which also shows the connections for the remainder of the apparatus. From the secondary terminals of the transformer pieces of No. 14 rubber-covered wire lead to the terminals of the spark gap.

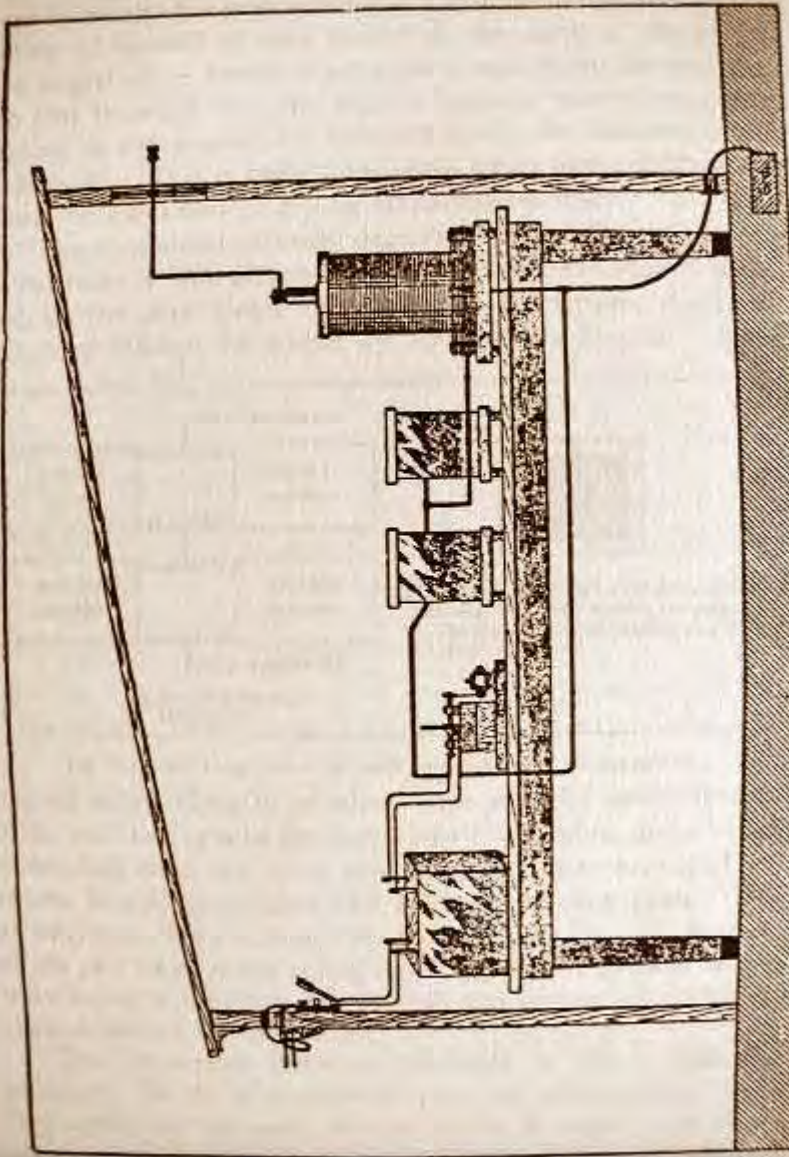

Fig. 110.—The apparatus assembled in the transformer house

From one terminal of the spark gap a piece of stranded cable, composed of 100 strands of about No. 24 insulated magnet wire, runs to one terminal of the condenser. From the other terminal of the condenser, a piece of the stranded cable leads to the movable clip on the primary of the oscillation transformer. The second terminal of the spark

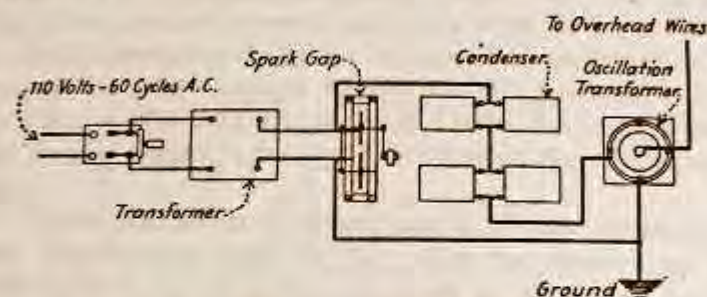

Fig. 111.—Diagram of connections for the apparatus

gap is connected by cable to the ground connection of the oscillation transformer and this in turn to a series of wires buried in the ground beneath the plot to be cultivated.

The high-potential, high-frequency terminal of the oscillation transformer connects with a piece of light copper rod, which extends upward and out of the side of the building, through a hole cut in the center of a pane of glass. This glass window should be at least 18 inches square and shaded on the outside of the building with a contrivance resembling an awning, in order that the surface of the glass may be kept as nearly as possible in wet weather. The copper rod passing through the glass is tipped with a connector to which the overhead wires of the plot are secured.

Wiring the Plot.—The high frequency current produced by the apparatus described is administered to the plot ground under cultivation through the agency of an over-

head network of copper wires and a ground connection consisting of strands of wire buried in the earth of the plot. The transformer house is preferably located at one end of the plot in order that the high frequency current may be carried to the area under cultivation by the shortest possible route. This is highly desirable, as an appreciable loss would be sustained in a long transmission line.

The equipment recently described is of sufficient power to cultivate a plot of ground embracing 5,000 square feet, and, in the case under the writer's observation, the plot measured 50 feet in width by 100 feet in length. The

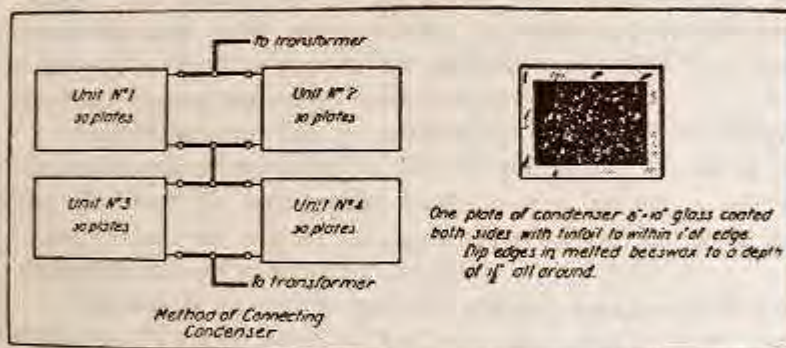

Fig. 112.—Showing how four units of condensers are connected ground wires, three in number, were run the entire length of the plot and spaced ten feet apart. Crossing these wires at ten-foot intervals were ten bridging wires arranged as shown in the illustration and soldered at each joint. In all cases the wire was of No. 16 bare copper. At the end of the plot nearest the transformer house, the ground wires were brought together in a rat-tail and connected with the ground lead of the apparatus.

The overhead network presents a more difficult problem. In the experimental plot ten wires spaced five feet apart ran the entire length of the plot and were sup-

ported at either end upon high-tension insulators held by posts which were of such a height that they suspended the wires seven feet above ground. At twenty-foot intervals on either side of the plot, additional posts were located and cross wires between each two of these posts completed the network and at the same time relieved the strain upon the slender wires running the length of the plot. As in the case of the ground network, all joints were soldered. The overhead connection is in the nature of a continuation of each of the long wires to form a rat-tail, grouping all of the wires where they are connected with the high-tension lead passing through the glass window of the transformer house.

The insulators on the posts may be of the conventional glass high-tension type or they may be cobbled up by grouping a series of porcelain cleats as suggested in the appended illustration. The best of insulation is none too good, particularly in damp weather, as the high-tension current leaks badly in its effort to find its way to the ground.

The actual time of treatment will naturally rest with the individual investigator. From one to four hours, both night and morning, is a fair dosage, and noteworthy results have been obtained with this average treatment. The plants or vegetables under cultivation should be planted in duplicate in a neighboring bed in order that comparisons may be made at frequent intervals. In order to put the experiments on a practical footing, the notes taken during treatment and subsequently should include data on the weight, amount of foliage, percentage of edible portion, quality of the latter, time required to bring plants to maturity, etc. These notes will be useful not only to the individual investigator, but to the world at large.

CHAPTER XVIII.

FURTHER NOTES ON PLANT CULTURE.

Every radio telegraphic transmitter, large or small, amateur or professional, is a potential cultivator of plant life. Through a simple conversion of the oscillation transformer, the apparatus to be found in the possession of every licensed radio amateur can be made to perform this practical service in connection with the so-called "kitchen gardens" springing up all over the country.

Following this line of reasoning, Mr. F. F. Picksley, an ardent experimentalist of Mamaroneck, N. Y., called at the offices of the author and made known his plans, which were formulated largely as a natural result of the order to dismantle all radio stations in 1917.

The entire stretch of ground planted measured 38 feet front by 110 feet deep. This plot was divided into two parts, one of which was electrified, and the other was without current, for purposes of checking results obtained.

The Distributing System

The system for distribution of the high-tension, high frequency current was simple. It comprised essentially a net-work of copper wire suspended above the garden at a distance of some 8 ft. from the ground, and a series of copper wires placed in shallow trenches beneath the ground.

In the case of our garden, the placing of the ground wires was a simple matter. The plot was first plowed, then raked, and finally the ground wires were placed in furrows

produced by means of a hand plow or cultivator of the kind sold in nearly every country hardware store. The ground wires, nine in number, were bridged at either end

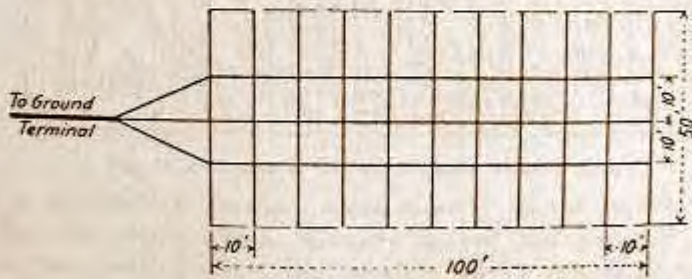
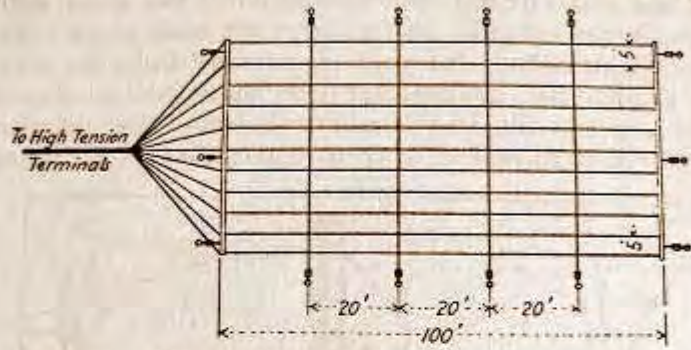

Plan of Ground Wires.

Fig. 113.—Plan of overhead and ground wire system

with a piece of heavy stranded copper wire. All joints were soldered before the wires were buried. The ground lead was a piece of No. 4 stranded copper wire leading

down a side of the house from the transformer apparatus and making connection with the nearer bridging wire beneath the ground.

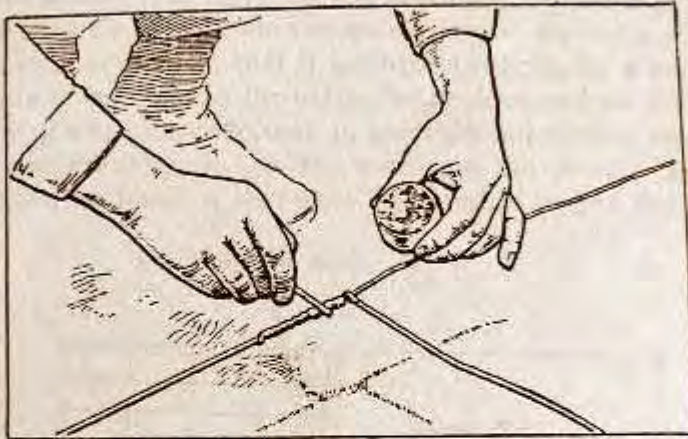

Soldering the buried wires

*To Right Method of Overcoming
the Weight of our Aerial Network*

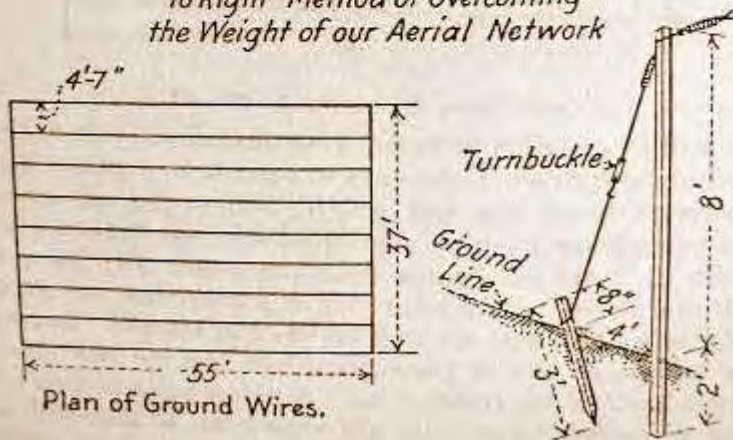

Fig. 114.—Plan of ground wires and method of putting in posts

The aerial network was formed by stretching four stranded copper wires between insulators secured to the supporting posts in the four corners of the electrified plot. Guy wires and turnbuckles stiffen the structure and enabled us to make the network taut. Smaller copper wires were stretched between the stranded conductors, forming the closed loop as shown in the drawing. All joints in this network were carefully soldered with the aid of a blow torch. A rat-tail, composed of wires leading from each of

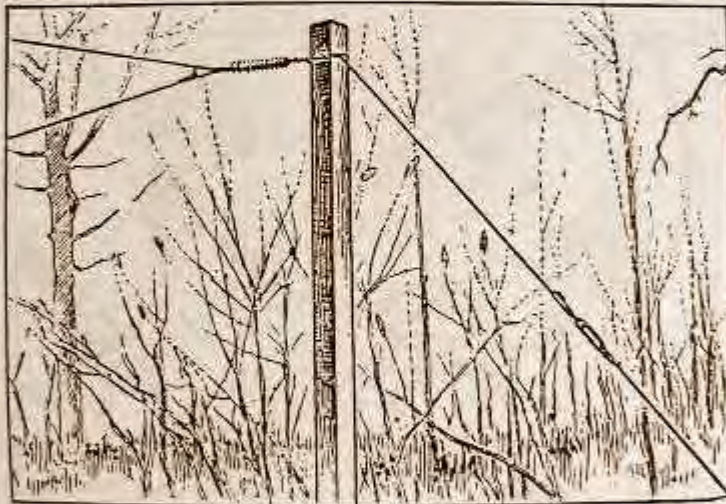

Fig. 115.—Method of holding overhead wires to posts

the longitudinal strands, leads directly to the switch outside the house which formerly served the purpose of a lighting switch when the wireless outfit was in commission. Indeed, the scheme of connection is exactly the same as that employed for wireless, the switch being so arranged that when current is not being sent through the network the switch connects the aerial network with the ground wires.

Construction Difficulties

A shelf of rock runs beneath the entire plot under cultivation. The depth of the soil varies from less than a foot to over four feet at different points. While this forms an ideal condition from the standpoint of vegetable raising, in view of the fact that it maintains practically a constant state of moisture in the earth, the rock caused no little difficulty when we undertook to erect the supporting poles for the aerial network. As the strain on the poles is considerable, we found it necessary thoroughly to guy the poles.

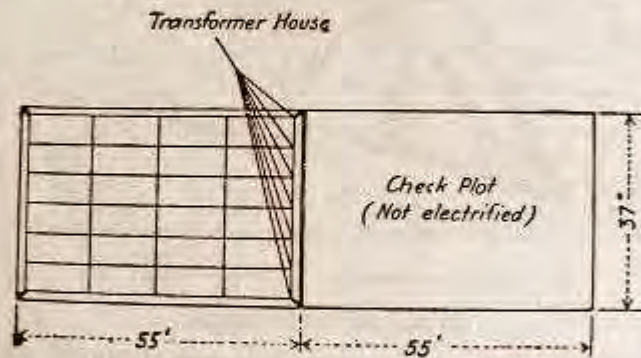

Fig. 116.—Connections of ground wires

and in this connection were forced to resort to various expedients such as the use of convenient trees upon which to fasten the guy wires. Where this was found necessary, we protected the bark by placing strips of wood under the loop of wire where it passed around the tree. In other cases, we were forced to rely upon stakes driven into the ground. We are not certain that the latter will stand the strain, and we may find it necessary to use "dead-men" at the ends of the guy wires. Be it understood a "dead-man" in this case is an anchor-like contrivance buried in the earth.

We used one 10-in. strain insulator of the high-tension variety at each pole.

In erecting the network, the posts were placed about two feet in the ground. In this comparatively small plot only four posts were used. The guy wires were placed next without any attempt being made to tighten them. Finally the stranded wires forming the closed loop were stretched tightly between the insulators on the posts and the joints soldered to insure non-loosening and good con-



Fig. 117.—Soldering ground wires with torch.

ductivity. The turnbuckles were next brought up to stretch the loop tightly. The longitudinal wires, five in number, were next stretched tightly between the two end wires of the loop. These points were soldered. Then the three transverse wires were stretched between the side wires of the loop and the joints soldered. This gave us a perfectly taut network of ample height to permit freedom of movement underneath it in cultivating the garden.

Vegetables Planted

Radishes, lettuce, peas, carrots, beets, onions, potatoes, and celery were planted in the garden.



Fig. 118.—Using small cultivator to prepare soil

Apparatus Required

Mr. Pickslay was the owner of a Clapp-Eastham Hy-tone transmitter of $\frac{1}{2}$ k.w. capacity, and this transmitter was used to produce the necessary current.

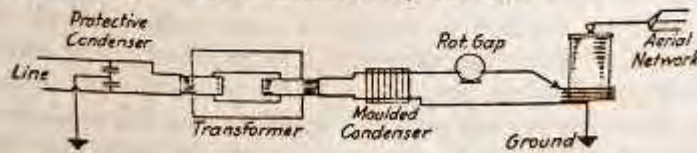

Fig. 119

The secondary of the oscillation transformer was composed of 100 turns of No. 18 annunciator wire wound in a single layer upon a cardboard cylinder $5\frac{1}{2}$ in. in diameter which slips within the edgewise-wound copper strip form-

ing the secondary of the oscillation transformer used for wireless purposes. This coil gives less than a half-inch spark when operated without any capacity attached to its terminal; however, when the aerial network is attached, the potential is so increased that a spark several inches long may be drawn from the coil. The diagram of connections is given in Fig. 119.

CHAPTER XIX.

A FOREWORD ON THE CONSTRUCTION OF ELECTRICAL APPARATUS FOR THE STAGE

In this chapter, the aim will be to present comprehensive directions covering the design and construction of the apparatus used in an elaborate electrical act suitable for the vaudeville stage. While many so-called electrical acts are already in the field, the effects produced are comparatively insignificant when one stops to consider the possibilities in this form of entertainment. No doubt most readers have seen the offerings referred to and the "stunt" of taking several thousand volts of electricity through the human body is by no means a new one at the present day. However, it is thought that the quipment to be described will offer many opportunities for the enlargement of the previously attempted exhibitions of the wonders of electricity with the result that the production, from a theatrical standpoint, will be sensational.

In this apparatus, the high-frequency current plays a very important part; indeed, many of the experiments are wholly dependent upon this form of current for their presentation. Therefore, it is thought advisable briefly to reiterate the nature of this current and its physiological effects upon the human body. It was discovered many years ago that if an alternating current of electricity be caused to oscillate with sufficient frequently, that is, to change its direction of flow a sufficient number of times per second, its muscular contractive effects upon the body would be les-

sened to a considerable degree. The commercial alternating lighting current which has a frequency of 60 or perhaps 125 cycles per second, is fatal to a human being if applied in sufficient quantities. Available data discloses that voltages of from 200 to 500 are dangerous and in some cases fatal where the frequency is of the commercial order. If, however, the frequency is increased to 10,000 cycles and upward per second, it has been found that several thousand volts may be taken through the body with comparatively little discomfort. A further increase to 100,000 cycles and over renders the current practically painless. The possibility of using this peculiar form of current in the production of unusual effects will therefore be appreciated.

Points to Consider.—Before starting work on any of the apparatus, the reader had best satisfy himself in his own mind just what feature of entertainment work he desires to take up. This section deals with the construction of practically every useful form of high frequency apparatus designed especially for theatrical demonstration. The assembly of the entire lot of apparatus as described would entail a considerable expenditure of time and money and there are cases where this outlay is scarcely justified. For instance, the platform lecturer would scarcely care to burden himself with the costly and cumbersome equipment so essential to the performer on the stage. For the benefit of readers to whom this elaborate equipment does not appeal, a summary of the various types of outfits will be made in order that the worker may make an intelligent selection whether he be a modest "suit-case" lecturer or vaudeville performer, a parlor entertainer, or a theatrical producer of the most extravagant type.

The one big feature of any electrical offering is the high frequency work. This fact is admitted by dozens of performers and lecturers alike. The very idea of "taking

thousands of volts" of electricity through the body and still living to do it over again, is theatrical in the extreme, and it is no wonder that so many so-called electrical kings have separated a gullible public from their dollars for years on the sole claim that a supernatural or other unusual power made it possible for them to take current at this enormous voltage through their bodies. The high frequency coil may, therefore, be regarded as the one essential part of the outfit, and the other instruments in the light of accessories.

Weight and Cost of Apparatus.—The largest apparatus described in this section will deliver sparks several feet in length. That this is spectacular and impressive, no one will gainsay, but the outfit weighs hundreds of pounds and requires for its operation several kilowatts of electrical energy. The utter uselessness of such apparatus, in the case of the lecturer, is at once apparent. Far better is it for him to make or purchase a small coil capable of giving an eight or a ten inch spark and taking its current from the nearest lamp socket. Furthermore, the large apparatus requires for its operation an alternating current, and this is not always obtainable. The only practical alternative is a rotary converter or motor-generator set, which in this large size, is very heavy and costly.

The small coil, on the other hand, may be built on the "kicking coil" principle, described in an earlier chapter, and in such event its operation is satisfactory on either direct or alternating current through the change of a simple connection.

The question of the high frequency outfit therefore resolves itself into one of whether the performance is to be given in a chain of small lecture halls or good-sized theatres. In the former case the small portable outfit is ample and certainly far more useful, while the latter use

would justify the best aggregation of paraphernalia the capital of the owner would command. The salaries of feature vaudeville acts are, as a rule, commensurate with the pulling power and therefore the attractiveness of the act itself. Recognizing this, it is certainly wise to put forward every effort in an endeavor to make the true vaudeville act as big, as spectacular, and, to sum it up, as impressive as may be possible. The results justify the expenditure.

In the construction of the apparatus the average reader is face to face with a problem. The manufacturer of standard apparatus will not even quote on this special material; the model shop wherein inventions are developed is too thorough and expensive; the average electrician knows nothing whatsoever about the apparatus in question; the typical machinist is worse than useless where complete assembly is concerned, as he is either too "rule of thumb" or too literal. The reader will wonder what he is to do.

The Home Workshop.—The answer is to build a home workshop. It is cheaper in the beginning and in the end, and if the apparatus is worth having and building, it is deserving of a proper birthplace. The tools required may be purchased for perhaps a quarter of the sum demanded by the combined carpenters, machinists, electricians and the rest of the vast army of mechanics, each one of whom does not know just what is desired, but is certain that he is capable of building it just the same.

The construction is best done in a spacious room wherein the apparatus can also be set up and tested, and the act rehearsed. This means, of course, the installation of electric service. The room should have plenty of open floor space rather than spacious work benches, although these are quite as essential within reason. The tool equipment may consist of a fairly complete set of wood-working tools and bench, an engine lathe of light construction but

of large capacity as regards swing, a small drill press and complete set of metal tools, such as pliers, hacksaw and files. With such an equipment the handy man—and it is assumed that the would-be entertainer is a handy man or he had better not start on the road with his outfit—may construct the entire set of apparatus with the assistance of a bright boy or even girl if she be mechanically inclined. And after the apparatus has been built by the man who intends to use it, who can gainsay the fact that he, better than anyone else, is prepared to take care of it and repair it if necessary? If some of the more intricate machine work, of which there is little, is beyond the capabilities of the amateur, then let him go to the regulation shop and have just that part finished up to drawings.

Working Drawings.—The question of drawings brings us to a point of vital importance. Before a stroke of work is done on the apparatus, each and every part should be depicted in a large drawing and all dimensions checked to determine their accuracy. The space available in this book has not rendered it possible to cover this detail with all thoroughness, but the individual worker should develop his design from the suggestions given, making his drawings complete in order that he may fully understand the construction of the various parts.

In no sense is the work of building the apparatus difficult and neither does it require the services of skilled labor. The ability to use tools in an intelligent manner and, what is far more important, a fairly intimate knowledge of the apparatus being built, may be said to constitute the qualifications for success. In order that the latter qualification may be obtained, it is suggested that the prospective builder diligently consult every book pertaining to the subject that he can lay his hands on. These books may be numbered on the fingers of one hand, and when one has assimilated

their entire contents, there is still a good deal to learn on the subject. But every iota of knowledge helps, particularly in the theoretical end, which does not necessarily mean the mathematical end. Probably the less mathematics the practical builder tampers with, the better he will be off, for the actual design of the apparatus has been spared him. What he needs is a good, sound knowledge of the characteristics of the high frequency current, and this may be quite readily obtained from a few good books. With knowledge and a fair equipment of tools, let him start in with what will probably prove to be the most interesting and fascinating work he has ever attempted.

CHAPTER XX.

THE CONSTRUCTION OF LARGE APPARATUS.

The construction of a high frequency transformer capable of throwing a five-foot spark will be considered first of all, for this piece of apparatus is probably the *chef d'œuvre* of the assembly.

The transformer consists essentially of a primary coil *B*, Fig. 120, of nine turns of heavy copper ribbon 2 inches wide and wound in the form of a spiral; a secondary coil of 600 turns of copper wire wound upon a wooden cylinder, *S*, Fig. 120; and a suitable means for holding the primary and secondary in their proper relation to each other.

The secondary cylinder presents the greatest constructional problem for the amateur workman and it is suggested that this be made at the mill unless the workman is equipped with a large speed lathe. The cylinder is built up of segments of whitewood, tapered to fit around the periphery of three wooden discs, one at each end and one in the center. The entire cylinder must be assembled without the aid of nails or metal of any kind and the best course to follow is to glue the slats or segments in place and further to secure them with wooden pins covered with glue and driven into holes drilled into the wood. The cylinder is 50 inches long and 20 inches in diameter. After the assembly is completed, the surface should be turned off in the lathe and given two coats of a black vegetable dye. All paints containing lead and carbon must be shunned in the treatment of this apparatus or electrical

"leaks" will be developed. There are several good black dyes on the market soluble in water or alcohol and any one of these may be used with impunity. After the surface of the cylinder is blackened and thoroughly dried, it may be given a coat of shallac, when it is ready for winding.

The winding is best done in a screw-cutting lathe as the turns are to be evenly spaced 12 to the inch. If the lathe is not available, an improvised winding machine may be constructed with the aid of two bearings to support the cylinder and a length of rod threaded 12 to the inch arranged to turn with the cylinder and to carry a guide for the wire as it is wound. The winding is of No. 22 D.C.C. magnet wire and the first turn is started 1 inch from one end of the cylinder. From this point it continues to within a like distance of the opposite end. A band of $\frac{3}{4}$ -inch copper ribbon is then placed around the remaining space at either end and the starting and finishing ends of the winding are soldered to the bands. The latter should not completely encircle the cylinder but a gap of $\frac{1}{4}$ inch should be left where the ends meet. The winding is to be given four coats of shellac, each coat being permitted to dry thoroughly before applying the next.

A brass bushing, having in it a hole tapped $\frac{3}{8}$ -18, is to be firmly secured in each head of the cylinder and connection made from the copper bands to the bushings.

Wooden discs, 21 inches in diameter, are to be fitted to the ends of the secondary cylinder in order to give it a finished appearance. Holes are bored through the centers of the discs, of course, to permit access to the bushings within.

The secondary cylinder is surmounted by a discharger composed of a brass ball mounted on the end of a rod which makes contact with the brass bushing in the top of the cylinder. A wooden cone is turned up in imitation of a

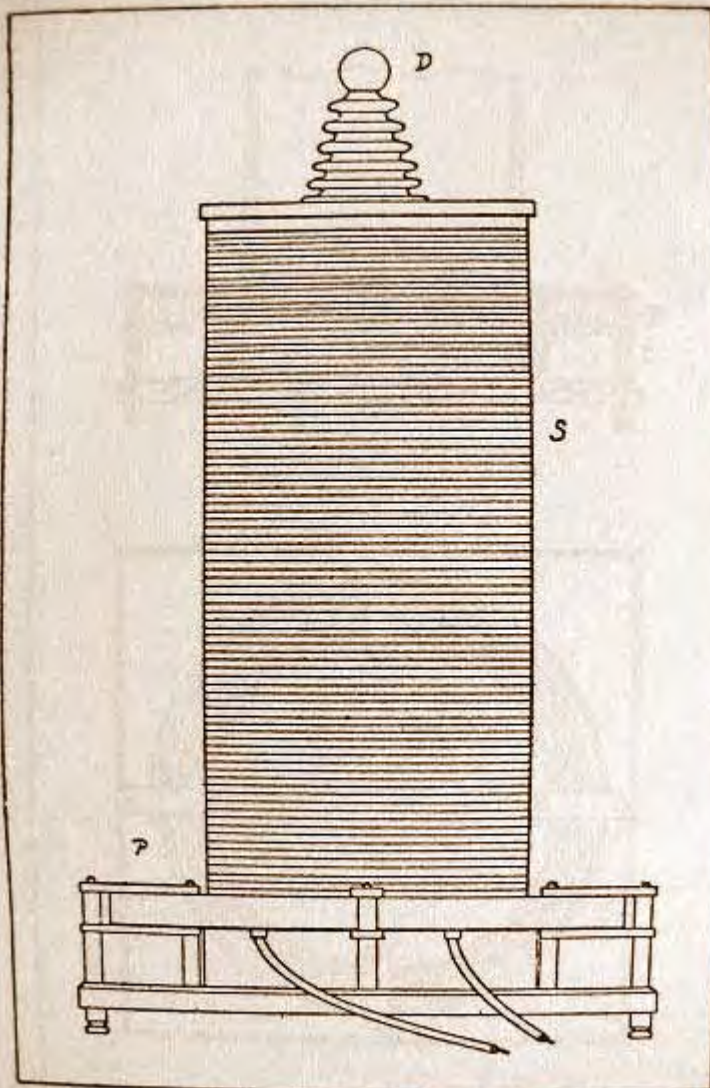

Fig. 120.—The oscillation transformer complete.

high tension insulator and the rod carrying the ball runs through the center of this cone.

The construction of the primary coil and base will be understood on reference to Fig. 121, which gives a plain view looking down on the primary from the top and also a side elevation of the lower portion of the complete transformer in cross section. It will be noted that the primary is composed of nine turns of heavy copper ribbon two inches wide and wound in the form of a true spiral. The ribbon is wound into its finished form with a double thickness of $\frac{1}{16}$ inch rubber belting between turns. It is taped at three or four places to hold it in place temporarily while the supports are being constructed.

The object of elevating the primary coil is to provide means of access to the under side in order that connection may be made with any desired turn. The coil is gripped between pieces of fibre bar *A* which are held in place by fibre bolts *B* and the whole is supported on the elevating posts *C* of fibre.

The base is of wood, and it should be mounted upon four glass or porcelain insulators. The finish of the base is preferably of the same color as that used on the secondary cylinder; the black vegetable dye provides a finish that is rich and pleasing in appearance and at same time rather unusual. If the copper primary ribbon is highly polished and lacquered, a pleasing contrast will result.

A square wooden box is mounted upon the base and in its top is a short bolt threaded to enter the hole in the brass bushing in the lower end of the secondary cylinder. A strip of copper ribbon makes connection between the bolt and inside turn of the primary spiral.

Connection between the primary and the balance of the circuit is established by means of special flexible cables which are made by binding 100 strands of No. 32 S.C.C.

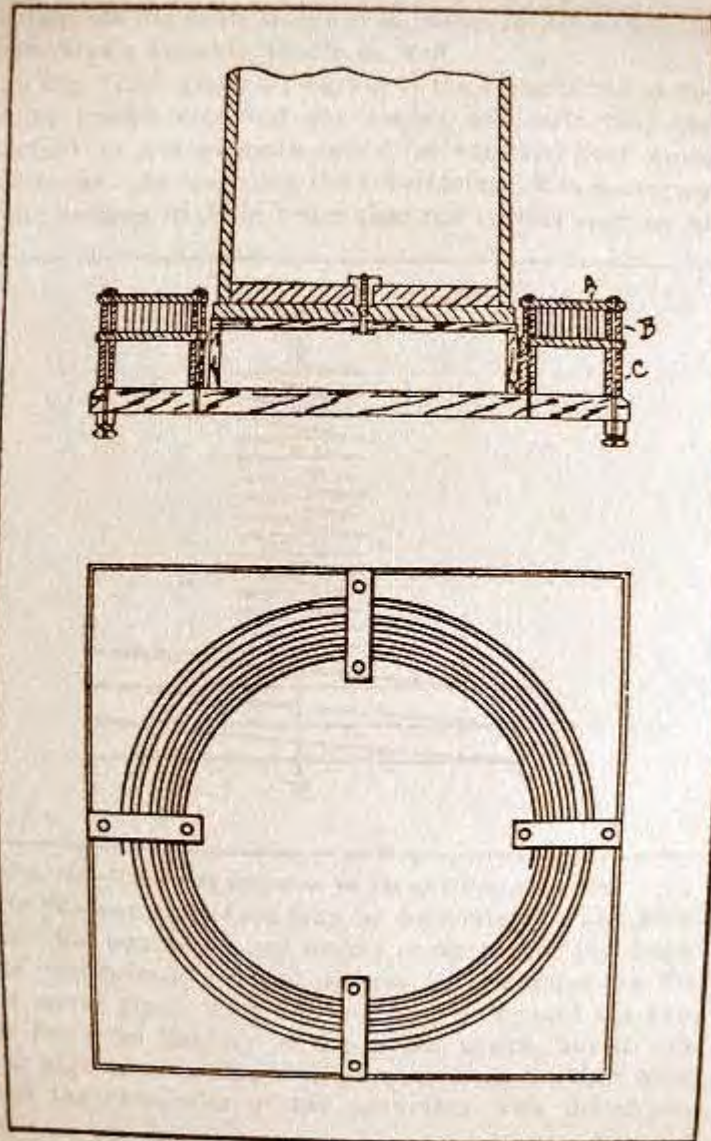

Fig. 121.—Section through base of oscillation transformer and plan view of primary

magnet wire with cotton tape. Each of the two cables should be about 5 feet long and tipped on each end with a special lug or connector. The construction of the connector or clip which makes contact with the primary ribbon is clearly shown in Fig. 122. The clip is made by cutting a slit in the end of a piece of hard brass rod $\frac{3}{8}$ inch in diameter by means of a thin hacksaw. The blades are rendered more springy by cutting away a portion of the metal from the back of each, and a hole is drilled into the shank of the clip to admit the wire of the cable. Each strand of

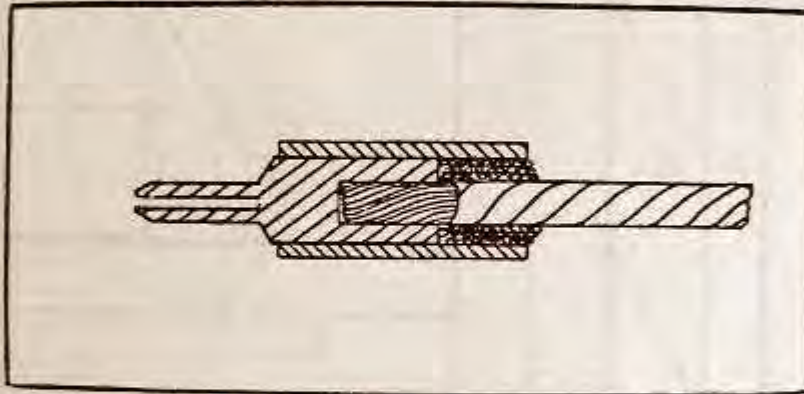

Fig. 122.—Clip which makes connection with primary turns

the latter is carefully cleaned of its insulation for a distance of $\frac{1}{2}$ inch and the bare ends of the wire are then twisted together after having been well coated with a good soldering paste. The clip is held in a pair of pliers and carefully heated over a Bunsen flame until the solder melts within the hole, after which the cable end is carefully inserted and sweated in the clip. The wire, where it enters the clip, is tightly bound with thread until it is equal in diameter to the shank of the clip. A piece of fibre tubing, making a tight fit over the shank, is then forced on and extended over the binding of the wire. This serves as a

protection for the cable where it is joined to the connector and provides a suitable handle as well.

In Fig. 123 is given a diagram of the connections of the complete transformer and the reader will note that the connection to the primary spiral is variable over quite a wide range. In operating the transformer, it is necessary to make various trials in order that the correct number of

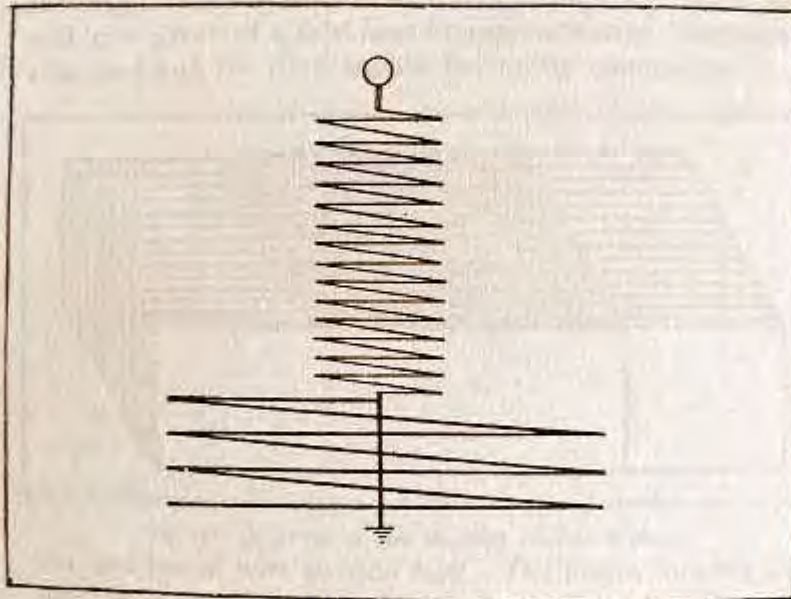

Fig. 123.—Diagram of connection for the oscillation transformer

turns to produce resonance may be determined. The point at which the secondary coil makes contact with the inside turn of the primary should always be grounded on the nearest water pipe. This will not only safeguard the performer from the liability of dangerous shock, but it will prevent high tension surges of current from striking back through the remainder of the apparatus with disastrous results.

The Transformer.—The transformer required for the operation of the coil described may be rated at approximately 4 k.w. It may appear to some engineers that the instrument is somewhat overrated, but in view of the fact

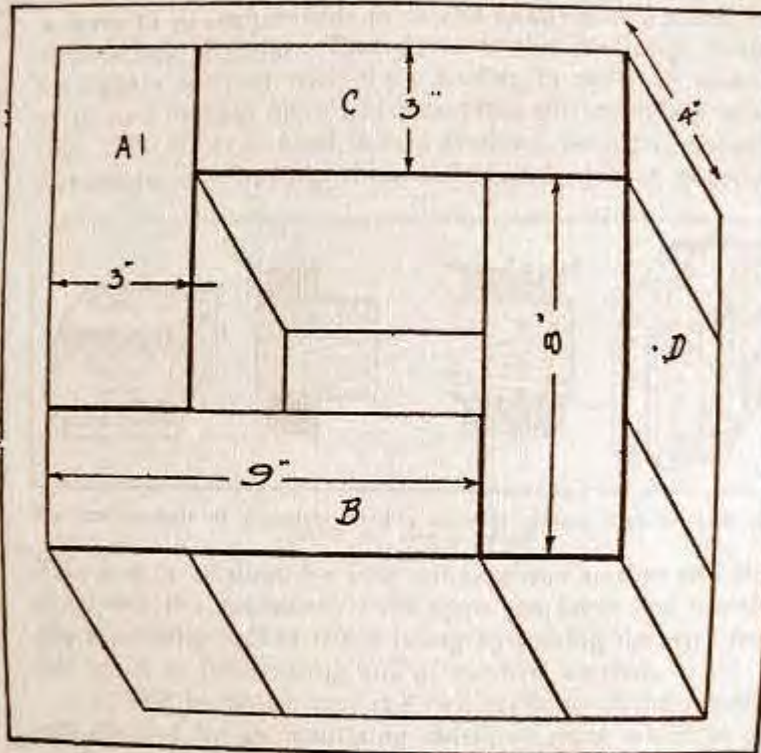

Fig. 124.—Details of the core with dimensions

that it is in use for periods of less than 20 minutes at a time it is believed that no difficulty will be experienced.

The core is built up of sheets of silicon steel .017 inch thickness and cut to the sizes shown in Fig. 124. Reference to this drawing will disclose the fact that 448 pieces of

each of the two sizes will be required. It is suggested that this steel be purchased from some transformer manufacturer already cut to size, as it is practically impossible to buy silicon steel in such a small quantity in the open market. Assuming that the steel has been obtained, the legs *A* and *E* of the core may be assembled by placing the pieces alternately first to the right and then to the left, showing a 3-inch overlap as indicated in Fig. 125. Each pile will have assumed a thickness of approximately 4 inches at this time and the pack should be tightly compressed in a

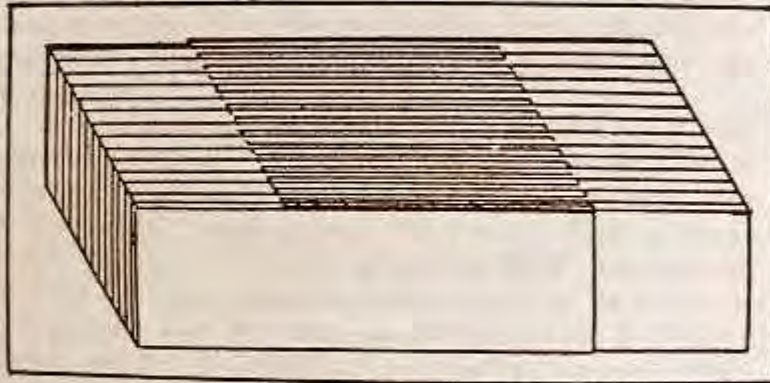

Fig. 125.—Short leg of core on which winding is placed

vise and bound with friction tape. The pieces forming the leg *B* may then be inserted one at a time to form the connecting yoke. This is rather a tedious process, but it offers the only practicable method of making a joint that is both mechanically strong and good from a magnetic standpoint. The core may then be set aside to await the primary and secondary windings before having its magnetic circuit completed with the remaining sheet iron strips *D*.

For winding the secondary, a form of square cross section similar to that shown in Fig. 126 should be employed. This form may be of wood and solid in construction. The

corners should be slightly rounded. The dimensions are given in the drawing. After the form has been mounted in the lathe between a spur-chuck and a center, it should be covered with a winding of a single layer of cord. Over the cord is placed a $\frac{1}{8}$ inch thickness of oiled paper, then a layer of $\frac{1}{16}$ inch flexible mica and finally 4 or 5 additional thicknesses of paper. Each layer of this insulation should be tightly secured with thick shellac in order to make a solid core or base upon which to place the secondary winding. The latter is done in two sections, wound in opposite directions and having their inside ends joined together.

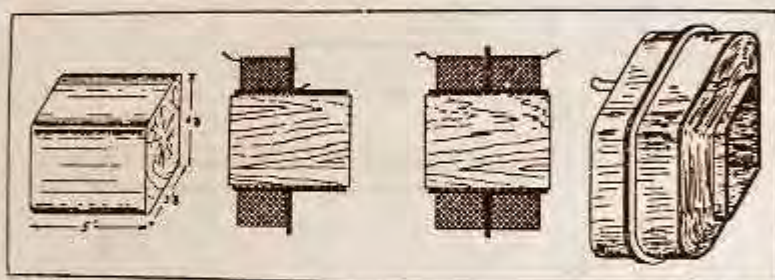

Fig. 126.—Details of secondary winding showing wooden block or form upon which the wire is wound

This end is attained by first winding one section and then reversing the secondary core upon the form and starting the remaining half of the winding by joining the wire from the spool to the starting end of the first section.

It will be noted that the two sections of the winding are divided by an insulating shield of mica which is cut to fit over the core and placed in position when the first section has been completed. The starting and finishing ends of the winding are soldered to pieces of thin copper ribbon about $\frac{1}{4}$ inch wide. After both sections have been completed the finishing layer in each should be covered with oiled paper to a thickness of $\frac{1}{8}$ inch.

The secondary winding consists of 3,525 turns of No. 25 enameled wire wound 75 turns per layer and 41 layers deep in each half of the secondary winding. Each layer of wire is separated from its neighbor by two layers of oiled paper which should be purchased in the form of a roll of paper tape two inches in width. As No. 25 wire winds 51 turns per inch it is obvious that there will be a margin of about $\frac{1}{4}$ inch along either side of the layer of wire.

The finished secondary is given a coat of armalac and the edges of the paper layers are liberally plastered with the compound in order that moisture may be prevented from entering. After the composition has dried, the secondary may be placed in position on one of the shorter legs of the core.

The primary is composed of 100 turns in all of double cotton covered wire. The first 70 turns to be wound should be of two No. 8 wires wound in parallel and the remaining 30 turns should be of a single No. 7 wire. Taps of heavy copper ribbon are to be brought out at 70, 80, and 90 turns in order that four variations of power may be available. The primary may be wound on the same form as the secondary and the insulating core on which it is wound should be built up similar to that on which the secondary was wound. The cord is wound upon the form in order that the coils may be removed without difficulty merely by withdrawing the cord. Short lengths of No. 8 stranded conductor are soldered to the primary taps to establish connection with a regulating switch. The primary may then be placed on the remaining leg of the core and the end pieces inter-leaved to complete the magnetic circuit.

The entire transformer may then be mounted in a suitable case of wood as shown in Fig. 127. Wooden blocks placed above and below the core serve to hold the trans-

former securely in position and the case is supplied with handles as shown in the drawing to facilitate carrying. The primary and secondary terminals should be mounted inside the cover in order that the working parts of the instrument may be entirely enclosed and thus protected from injury in shipment. If the case is substantially made it will serve as a shipping crate of convenient and effective design.

The secondary wires are brought to suitable terminals mounted on pillars of fibre inside the box while the primary terminals are brought to the contacts of a regulating switch likewise mounted on the wall of the case. The

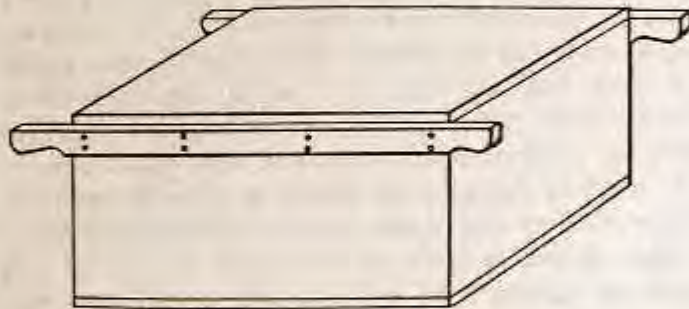

Fig. 127.—Case or container for the transformer

winding of the transformer is so designed that a consumption of current varying from 2 to 4 k.w. may be obtained.

The Spark Gap.—The apparatus previously described is designed for use with a rotary spark gap. Reference to Fig. 128 will disclose the fact that the spark gap is of simple construction and that it consists essentially of a disc of $\frac{1}{8}$ -inch aluminum, carrying 12 discharge points or studs of nickel steel, mounted upon the shaft of a small alternating current motor and surrounded by a housing of wood which serves the double purpose of a muffler to deaden the

noise of the spark discharge and a support to carry the stationary electrodes *E* in Fig. 128. The drawing represents a side elevation of the complete gap shown partly in cross section in order that the relative positions of motor, rotary disc and stationary electrodes may be shown. Fig. 10 shows an end elevation of the gap housing and it also serves to indicate the position of the stationary electrodes.

Attention should first be directed to the rotor of the gap. This should be laid out on a piece of $\frac{1}{8}$ -inch sheet aluminum rather more than 10 inches square. After finding the center, a circle with a diameter of 10 inches is inscribed upon the aluminum and then a 9-inch

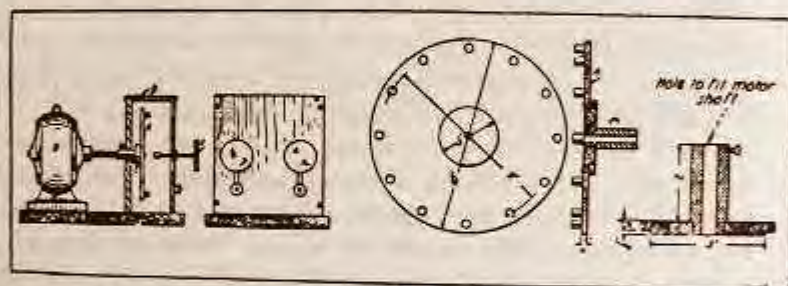

Figs. 128 to 131 inclusive.—The rotary spark gap complete and in detail

diameter circle is laid out and finally one of 3-inch diameter. The sheet of aluminum is then mounted upon a wooden faceplate in the lathe and a cut taken quite through the metal on the line of the smallest circle, thus leaving an opening 3 inches in diameter when the disc of metal is removed. A similar cut is taken on the largest circle resulting in the rotor disc which is now ready to be mounted upon the insulating hub of fibre, indicated at *C*, in Fig. 130, which gives an elevation and section of the rotor disc complete.

The insulating hub is turned up from a piece $\frac{3}{8}$ -inch sheet fibre to the dimension given in the enlarged drawing.

Fig. 131. The reader will note that the fibre hub is mounted upon a boss of brass which is threaded into the fibre and riveted over on the end to prevent its working loose. The brass piece is drilled with a hole of a diameter to take the motor shaft and a set screw provides a means for securing the boss on the shaft. The final cut which brings the fibre hub to the diameter of the hole in the aluminum disc should be made after the hub has been cut roughly to size and mounted upon the brass boss which is in turn mounted upon an arbor in the lathe. This will insure absolute truth in running.

The aluminum disc should next be divided with 12 radial lines running from the center and crossing the 9-inch circle at 12 equi-distant points. At each point a clearance hole for a No. 10-24 machine screw is drilled. Twelve cylinders each $\frac{3}{4}$ -inch long should be cut from a piece of nickel-steel rod $\frac{1}{4}$ -inch in diameter and each cylinder drilled and tapped in one end for a No. 10-24 screw. The cylinders may then be secured in position on the aluminum rotor and the disc mounted upon its hub of fibre. It is secured thereon with 6 rivets which may be brass escutcheon pins inserted in snugly fitting holes drilled through aluminum and fibre. The heading over should be done very carefully and on the aluminum side. The rotor, which is now finished, may then be mounted upon the arbor in the lathe in order to test for accuracy in running and, if the final cut on the fibre hub has been carefully taken and all burrs removed from the edge of the openings, the disc cannot run other than true.

The reader's attention is next called to the housing which consists essentially of a box of suitable size built up from $\frac{3}{8}$ -inch whitewood and lined throughout with sheet asbestos. A hole is drilled in the rear of the box to admit the boss of the rotor. The box is assembled with

screws throughout and the top piece, *D*, Fig. 128, is made removable in order to afford access to the interior of the case. The front of the box carries the stationary electrodes of the gap and the construction of these demands our attention next.

The stationary electrodes consist of a pair of the $\frac{3}{4}$ -inch nickel steel cylinders mounted upon threaded $\frac{1}{8}$ -inch brass rods supported in brass bushings which are threaded into the wooden front of the case. A 3-inch disc of fibre on the end of each of the threaded rods provides an adjusting handle by means of which the clearance between the studs on the rotor and the stationary electrodes can be closely regulated. A strip of heavy copper ribbon establishes connection between each stationary electrode and a binding post placed a few inches beneath it.

The gap may now be assembled according to Fig. 128 which shows the relative positions of the various parts so clearly that further description is unnecessary. The motor may be of the ordinary fan motor type of $\frac{1}{8}$ H.P. or even less and its speed should be about 1800 revolutions per minute. The method of mounting the motor is, of course, dependent upon the nature of the base or bed plate. The builder's ingenuity will doubtless suggest the best form of mounting to meet his individual requirements.

Care should be taken to see that there is practically no end play in the motor, for if such were the case, the clearance between the discharge points could not be maintained at a uniform value.

The Oscillation Condenser.—Before proceeding with the description of the condenser, it may be well to state that this particular feature of the outfit presents many difficulties in its design in view of the fact that the condenser is to be subjected to much rough handling and moving about. The data offered herewith is for a condenser hav-

ing glass plates for its dielectric, but the author would suggest that this material, while highly satisfactory for use in a condenser to be used in but one place, is obviously subject to breakage and is at a further disadvantage from point of weight. Its use is suggested in this work merely because the stock is readily obtained and this at a low figure. Sheet mica, while several times as costly, is far superior in every way and its use is strongly recommended to those

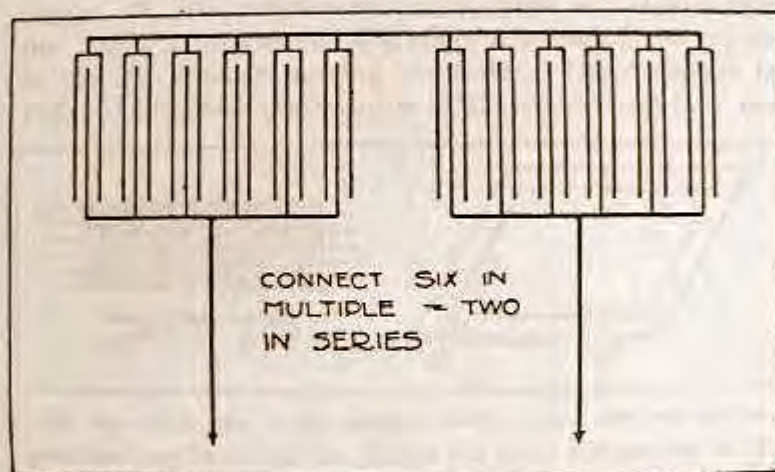

Fig. 132.—Showing how condenser is connected six units in multiple and two in series

who feel that the extra expense is justified by the advantages gained.

For the condenser proper, 120 sheets of 8 by 10 inch photographic glass will be required. This glass, in the form of discarded negatives, may be obtained from almost any photographer for a small sum. In addition to the plates above-mentioned, the builder will require some 24 plates additional to serve as cover glasses for each con-

denser unit. A few extra plates to replace possible broken or defective ones will not be amiss.

The first operation will be to clean the emulsion from the glasses and this is readily done by soaking the plates in hot water. It is not essential that the plates be made perfectly clean of the emulsion if the plates have all been developed and the silver dissolved, but it is desirable to get the surface and particularly the edges for a space of an inch or more as clean as possible. The plates, when cleaned and dried, are to be placed in a warm oven prior to having the metallic coating of tinfoil placed on each side. This coating is of the heavy foil used by florists and may be obtained in strips 48 inches long and 6 inches wide at almost any florist's shop. It comes in packages of one pound and averages some five strips to the package. The foil should be straightened out and cut off into rectangles 6 by 8 inches in size in order that when secured to the glass it will leave a margin of an inch all around. (See Fig. 133.)

The condenser is made up into units of ten plates each and each plate is to be coated on both sides with the tinfoil. In all there will be 12 units connected up as shown in Fig. 132, that is, two sets of six units each connected series-multiple.

To coat the plates the builder should provide a lump of beeswax and a "pounce" made by enclosing a wad of cotton within a soft cloth. A warm plate is taken from the oven and laid upon a cloth-covered table top. The lump of beeswax is rubbed lightly across its surface to provide a thin and even coating. A sheet of tinfoil is immediately placed in the center of the glass and rubbed into close contact with the pounce, starting at the center and, with a circular motion, working out toward the edges. This will result in a perfect union of glass and foil at all points. The plate is immediately reversed and the other side coated in

like manner before the plate gets too cold to melt the wax. The remainder of the plates are to be treated in a similar manner when they are ready for the connecting lugs, after having had their edges dipped in melted wax far enough to cover the edges of the foil for a space of an inch or so to prevent brush leakage.

The lugs are of thin copper ribbon, tinned at one end and affixed electrically to the tinfoil at alternate ends on both sheets of foil with a deft application of the soldering copper. A little practice on a scrap plate will soon enable the worker to master the operation of soldering the copper to the foil without melting the latter. The drawings in Fig. 133 illustrate the location of the connecting lugs and

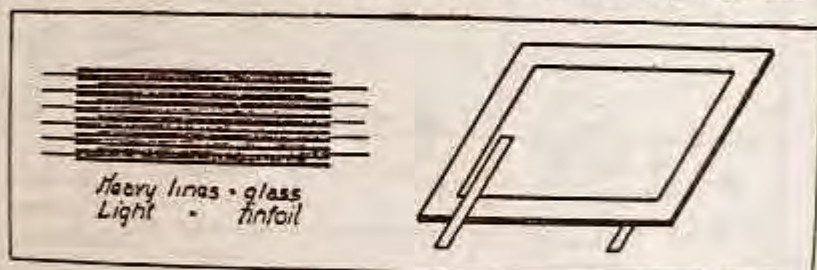

Fig. 133.—Single plate of the condenser coated on both sides with tin foil also the way in which ten plates are piled one on top of the other to form a complete unit. This assembling having been done with the entire lot of plates, the projecting lugs may be clamped with the pliers and soldered to short lengths of copper ribbon ready for connection with the bus-bars of the condenser. The plates of each unit should be bound with tape to afford mechanical strength and ease of handling. A plain piece of glass is placed on either side of each unit under the binding tape.

The twelve units are to be assembled in a strong wooden case and each unit should be separated from its neighbor by strips of wood covered with felt. Connections

are made as shown in Fig. 132, to bus-bars consisting of several strips of copper ribbon fastened together. The connections with the outside of the case are by means of heavy flexible cables made by binding a number of strands of fine insulated copper wire under one cover.

Setting Up and Operating.—The connections of the apparatus are simple as the accompanying drawing shows, and it is only in some few particulars that the author need supplement with further explanation. (See Fig. 134.)

A switchboard is highly desirable but not at all essential to the successful operation of the apparatus. One may be made quite simply and without the expenditure of much time or money. A pilot lamp, to enable the operator to see the control switches in the dark; a 50 ampere double pole, single throw knife switch to control the transformer circuit; and a small snap or knife switch for the spark gap motor circuit, will complete the equipment of such a simple board. This adjunct to the outfit may be made quite elaborate, if desired, just for the theatrical effect it may have if placed upon the stage. In this event, the board, which, may be of wood treated with a fireproofing compound should be finished eventually in a dead black to simulate slate. The switch equipment may be supplemented with fuses, imitation bus-bars and additional lights. An ammeter and a voltmeter will not only add to the appearance, but will also be of practical service in the operation of the apparatus.

The transformer requires a current of from 40 to 50 amperes at full load and the leads from the stage pocket must necessarily be of heavy cable. The stage cable used in connection with motion picture arcs is admirably adapted to this purpose and the outfit should include from 50 to 100 feet of cable.

Connection between the transformer secondary and the

rotary spark gap electrodes may be made with the high tension cable used in the ignition circuit of automobiles. This cable is to be fitted with substantial lugs as in use it will have to be connected and disconnected a great many times.

The oscillation circuit comprising spark gap, condenser and primary of oscillation or high frequency transformer should be connected with the cable.

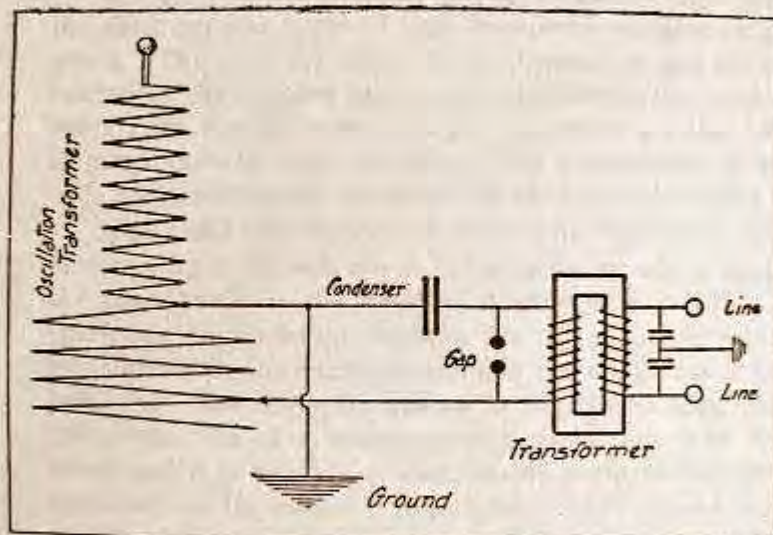

Fig. 134.—Diagram of connection for the apparatus

Prevention of Kick Back.—The ground connection shown in the diagram is of the utmost importance as without it high voltage surge back through the transformer wires will be almost sure to puncture the insulation of the transformer. To further protect the latter and to safeguard the house wiring, a protective condenser should be connected across the transformer primary at the point where the line wires are connected. This condenser is

made by joining two 2-mfd. telephone condensers in series across the line and grounding the neutral point or wire that connects the two.

For the sake of simplicity, the spark gap is shown as a stationary one rather than a rotary. The connections are, of course, the same for the two.

When all has been connected up, the spark gap electrodes may be adjusted to the point where they just miss the rotating member and the gap motor started. For this first test, the primary clip of the oscillation transformer may be placed on the center turn to permit of variation in either direction as required to establish resonance. The main switch may next be closed and the ball discharger at the top of the oscillation transformer should send forth long streamers of fire with a terrific cackling noise. An adjustment of the clip on the primary from one turn to another, and a variation in the length of the spark gap, will soon enable the operator to obtain resonance. This point is indicated by the longest streamers. At its maximum efficiency, the coil will send forth a spark that will dart a distance of more than five feet to a wire attached to the ground and brought near the discharge terminal. A strange feature of this experiment is the fact that the secondary cylinder is but 50 inches high and, rather than dart downwards, striking the primary of the coil, the spark will break down a far greater distance in a horizontal plane and still farther if the ground connection is placed overhead. This is a peculiarity of high frequency discharges.

CHAPTER XXI.

LARGE TESLA AND OUDIN COILS FOR THE STAGE.

In the present chapter, the specifications for two of the most popular types of high frequency transformers are given. The coils are complete in themselves and for their operation, the exciting apparatus described in the preceding chapter, or else the quenched gap apparatus covered in the former chapters, may be used. The proportions of these coils are excellent for transformers of larger or smaller size.

The Tesla transformer illustrated in Fig. 135 is capable of throwing a 50-inch spark between terminals if made in the size shown in the detailed drawings, Fig. 136. This spark can be produced through the use of a two kilowatt transformer in the exciting circuit if the apparatus is tuned properly. The resonator shown in Fig. 137 is designed for the production of a comparatively short, but very heavy spark and it is capable of remarkable performances in the hands of an ingenious manipulator. The various experiments such as lighting lamps with current taken through the body and igniting cotton or paper with sparks taken from the fingertip are well within its scope and this on a big scale. The coil is also excellent for the generation of a very high frequency current at high voltage for the production of a bluish halo or glow which seems to come from the extremities of the body when the performer operates in the dark.

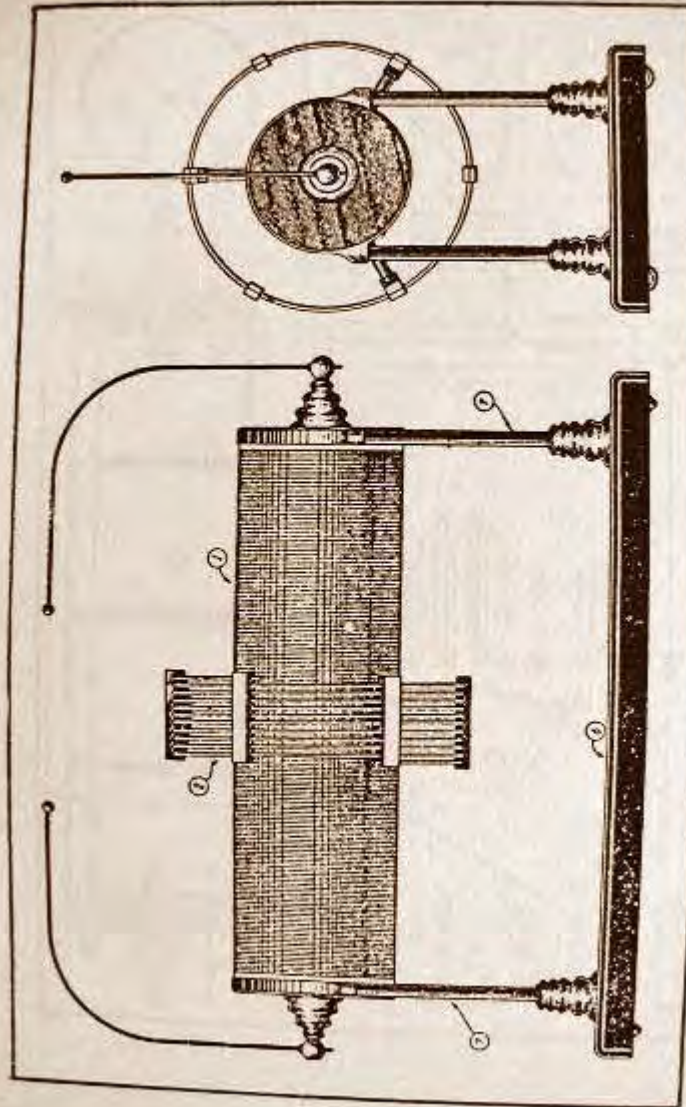

Fig. 135.—Tesla transformer capable of giving a 50-inch spark. The various parts are separable to permit of economy in packing for transportation

Rather than attempt a minute description of each operation in the construction of these coils, the author will endeavor to cover the constructional features in each case, believing that the reader is sufficiently well-versed in mechanics to be able to read the drawings without difficulty. The construction is practically identical in the two designs and a description of one will suffice for the other.

The most difficult part of the work is the building of the secondary drum indicated by 1 in the drawings. This is a wooden cylinder with wooden heads. The difficulty is found in the fact that the builder must not use metallic nails in the assembly. This is not insurmountable, however, for the shoemaker uses a substitute that fills the bill very nicely. His sharp wooden pegs may be driven like nails if the precaution is taken to start the hole with an awl or drill. If the builder has no lathe, he may order the wooden disc, which constitute the heads and intermediate forms for the cylinder, turned to size, from the mill. The wall of the cylinder is composed of wooden slats placed closely and glued and pegged to the discs. The construction will be materially assisted if holes are bored in the discs prior to assembly and a long curtain pole passed through to line them up. The pole is removed before the last few slats are placed in order that the brass bushings shown in the cylinder heads may be inserted and secured. After this, the final slats are placed in position, glued and pegged.

The cylinder may next be mounted upon a pair of horses and arranged to revolve through the agency of a short length of iron rod screwed into each bushing. The rod should be flanged in back of the threaded portion to prevent the strain on the bushing that would otherwise be present. With the cylinder between horses and a staple driven over each spindle, the builder may proceed to finish

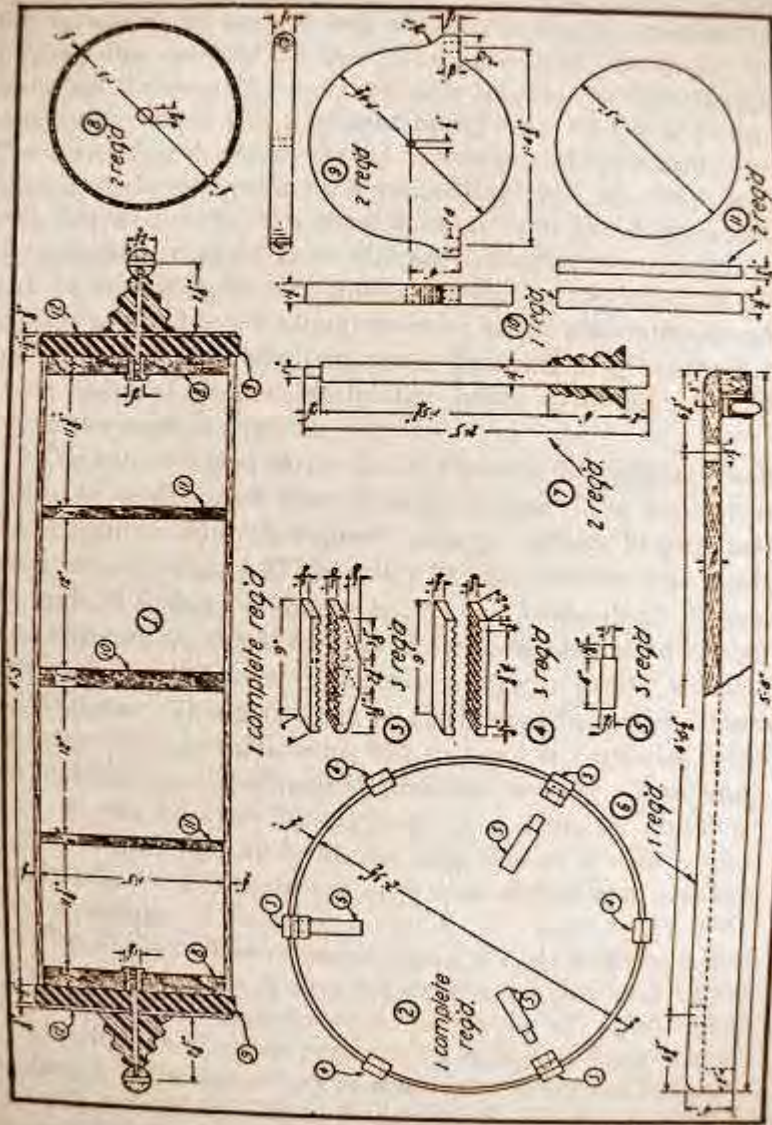

Fig. 136.—Details of the Tesla transformer

off the surface. A plane run along the slats will take off the projecting corners and a final rubbing with coarse sandpaper will bring the surface to a fairly smooth condition.

The winding surface is prepared by covering the cylinder with several layers of heavy wrapping paper, each layer being thoroughly soaked with shellac before the next is applied. The easiest and best way to do this is to purchase a roll of paper and place it in hangers beside the cylinder. The Tesla secondary may be wound in two sections with a space between at the centre of the coil. This space will provide for the legs that support the primary helix as shown in the drawings. The wrapping paper need therefore be only half the length of the cylinder in width in order to fully serve the purpose.

When the cylinder is covered and the paper and shellac have dried quite hard, the winding may be done. The exact size of the wire on the Tesla secondary is of small importance. The only requisite is that the number of turns be kept between 600 and 800. There should be an appreciable space between each turn and its neighbor, however, and this may govern the gauge of the wire employed. It is difficult to secure any wire larger than No. 22 in a length sufficient to wind the cylinder in one piece and a splice is not to be desired. If, therefore, No. 22 B. & S. gauge, double cotton covered magnet wire is available, it may be wound 12 turns to the inch, making in the neighborhood of 300 turns in each half of the winding. The two halves of the winding must be in the same direction; that is to say, the one half is a continuation of the other. This is easily assured by starting at the left end of the cylinder, for instance, and winding until within $1\frac{1}{2}$ inches of the centre. Here the wire is secured with a wooden peg and a jump taken over $1\frac{1}{2}$ inches to the other side of the centre of the cylinder. Another peg secures the start-

ing turn and the second half of the winding is completed, turning the cylinder in the same direction. In order to maintain the space between turns a loop of cord is passed over the cylinder and a weight hung from its lower point. The turn of cord, which should be heavy and approximately $\frac{1}{8}$ inch thick, will guide each succeeding turn, spacing them with fair accuracy. An experimenter who has built a set of apparatus recently from the author's directions, advises that he was able to straighten up the entire winding by running a metal comb along the wire as an assistant turned the cylinder. The winding, when finished, is given half a dozen coats of shellac, each coat being dried thoroughly before the next is applied.

The construction of the helix forming the primary will readily be understood from the drawings. The conductor is a length of $\frac{1}{2}$ -inch copper tubing, rubbed bright, and coiled into a helix of $27\frac{1}{2}$ inches in diameter for the Tesla coil and 26 inches in diameter for the resonator. A material superior to the tubing is the edgewise-wound copper strip that is now used in nearly all high grade wireless transmitters. This strip can be purchased in a spiral from any large wire manufacturer, but to bend it edgewise without buckling is a mechanical problem worthy of an engineer. It can be done by rigging up a drum of metal arranged with clamps to hold the strip flat as it comes from the reel, but the task is scarcely one within the province of the amateur.

The Tesla coil is mounted upon a base equipped with casters in order that it may be moved quickly and easily. The secondary is supported by four rods of wood which are mounted in wooden bases in imitation of high tension insulators. The secondary is removable from the supporting rods merely by lifting it off, the rods terminating in plugs which fit sockets in the heads of the cylinder.

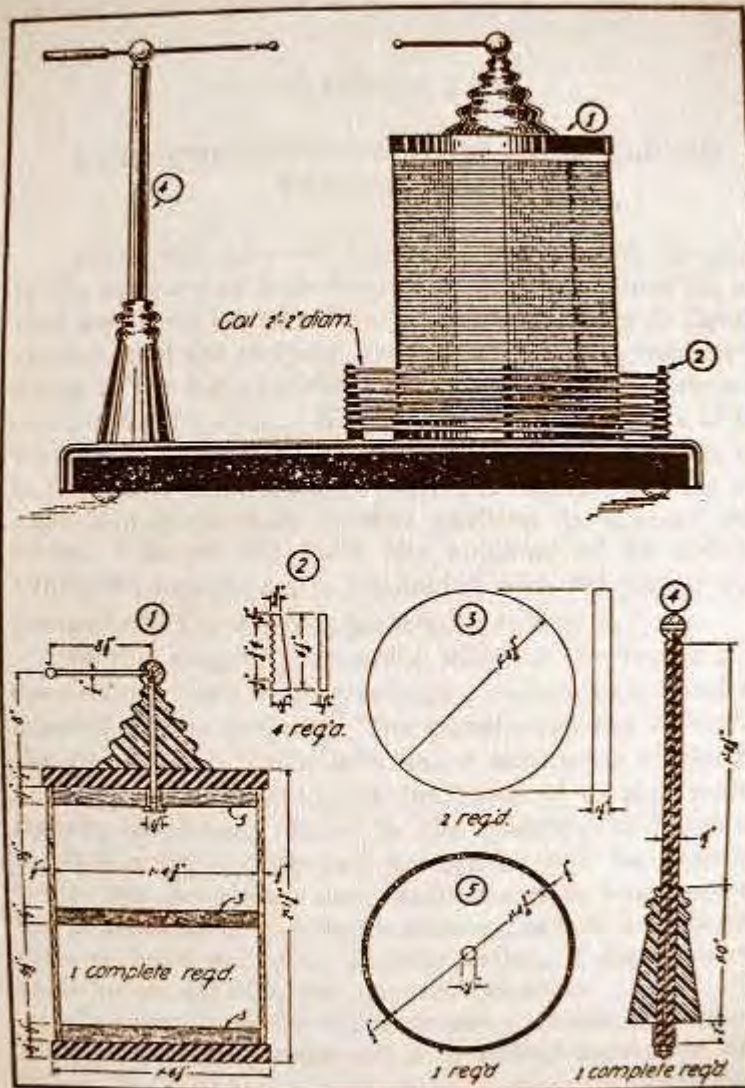

Fig. 137.—The Oudin resonator complete and in detail

rods themselves are removable from the base by lifting them from sockets therein. The primary helix is supported on the secondary cylinder by the three legs as shown in the drawings. The helix is so springy that there is no difficulty in springing the third leg into position after the helix has been placed over the cylinder.

The object of having all of the parts removable is of course to permit packing to be done effectively and without the enormous cases that would be necessary if the coil were in one piece. The resonator is made separable in the same manner.

The ends of the Tesla winding are connected to the discharge rods through the rods and balls shown in the sectional drawing. The primary is entirely independent and its only connection with the secondary is an inductive one. With the resonator, however, the case is different. The lowest turn is connected to the bottom turn in the primary helix and this in turn to a common ground terminal. The discharge rod 4 is also connected with this ground wire beneath the base.

Regarding the resonator, little further need be said save for a few words about the winding. This is in one continuous layer of about 350 turns. As the voltage is lower, this winding may be of No. 18 annunciator wire wound close and most carefully coated with shellac in six applications. The practice of winding the turns close is to be avoided if possible for there is extreme likelihood of the current leaping across through the insulation. A separation of a single turn of thin cord will help materially.

In closing it may be well to state that the suggestions given in this chapter are intended for the amateur worker who is not equipped with a lathe sufficiently large to take the cylinders. If the individual is so fortunate as to have access to such a large lathe, he may disregard most of the instructions and proceed in the regular manner.

CHAPTER XXII.

THE CONSTRUCTION OF A WELDING TRANSFORMER.

While this piece of apparatus can scarcely be placed in the category of high frequency apparatus, since the current employed is the ordinary 25, 60, or 125 cycle lighting current, still the welding transformer forms a valuable addition to the high potential apparatus used in an electrical offering on the stage. The feat of grasping a piece of iron wire, as thick as a pencil, between two pairs of tongs held in the hands and causing the wire to become red and even white hot while held in that position, is a stunt which seldom fails to call forth the applause of an audience. When the experiment is conducted with the proper scenic atmosphere, the effect is materially enhanced.

In this chapter the reader will find the details of the construction of a low-voltage transformer admirably adapted to this purpose. The transformer can be built by the average handyman who has a smattering of electrical knowledge and who knows the value of careful work as regards insulation. Later in the chapter, the design of a suitable stage setting and accessories will be described. While this experiment may readily be made one of a number grouped up into a single offering, still it is quite complete in itself and with embellishments, it may form the basis for an act of a few minutes' duration.

In order to make the description clearer, the various parts of the transformer will be described separately, each

under its proper heading. The transformer is designed for operation on a 110-volt, 60-cycle alternating current circuit and when the load is applied, the current in the primary is approximately 26 amperes. The secondary current at 11 volts is in the neighborhood of 250 amperes and this is sufficiently large to make quite a display.

The Core.—The core of the transformer is of laminated iron or preferably silicon steel .017 inch thick and cut into pieces as indicated in Fig. 138. From the diagram the reader will note that two sizes are required, *i. e.*, 3 by 6 inches and 3 by 8 inches, respectively, and 340 pieces of each size will be needed. The steel for the core may be obtained cut to size and ready to assemble from certain transformer manufacturers who buy the material in large quantities and cut it with a gate shear.

Fig. 140 shows how the 3 by 8 inch pieces are assembled with the ends projecting alternately three inches first on one and then on the other side. The strips are divided into two piles of 170 pieces each and each pile is then built up as shown in Fig. 140 to make two cores, each three inches thick. A generous wrapping of tape and three layers of press board make the cores ready for the windings.

Primary and Secondary Winding.—The secondary is wound over the primary on each leg of the transformer. For this reason the primary winding will be considered first. As mentioned before, the winding described is for use on a 110-volt circuit; if the builder desires to wind for a 220-volt circuit, he should substitute twice as many turns of a wire three sizes smaller in the primary only. The windings here mentioned are figured at but 500 circular mils per ampere, but in view of the fact that the transformer is used for only a few minutes at a time, the heating will not be excessive.

The primary consists of 120 turns in all and so arranged that 90 turns may be used if desired. The winding is of No. 9 D.C.C. magnet wire in four layers of 30 turns per layer. Two layers are wound on each leg. With reference to Fig. 142, the winding is started by soldering the end of the wire from the spool to the end of a piece of stout copper ribbon which is then insulated with a layer of paper and the winding continued over it for one layer. This

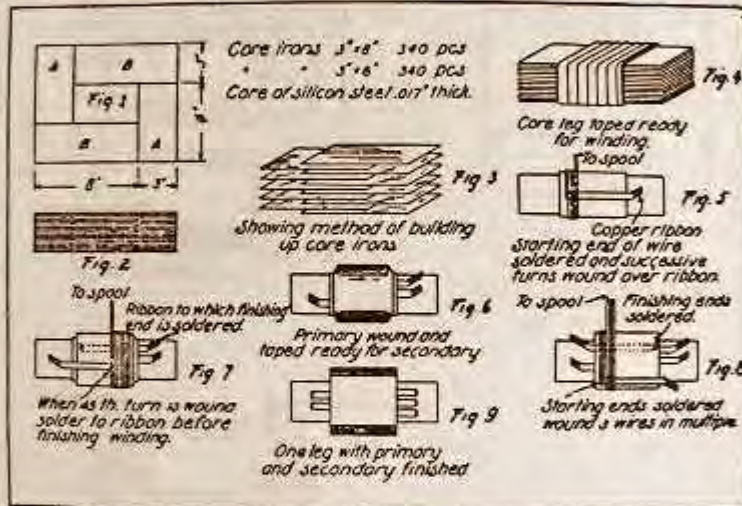

Figs. 138 to 147 inclusive.—Details of the welding transformer

prevents the annoyance of the first turn coming loose after the winding is removed from the lathe.

Over the first layer of the primary is placed a layer of press board and then the second layer of wire is wound until the 45th turn is reached. At this point a tap of copper ribbon is taken as shown in Fig. 143. Over this the winding is continued until the 90th turn is in place. This turn is soldered to the tip of a third piece of ribbon previously placed so that the winding holds it. The same

procedure is repeated with the other core leg and two layers of press board fitted ready for the secondary winding.

The secondary consists of 10 turns in all, five to each layer. The winding is composed of three No. 4 D.C.C. wires wound in multiple as shown in Fig. 146. The wire should be on three spools arranged conveniently in back of the operator who should wear canvas gloves in handling the heavy conductor. The wires will have to be tapped in place with a small wooden mallet. The starting ends are soldered to a piece of heavy copper strip, the winding done, and the finishing end secured in a similar manner. A substantial covering of press board finishes the windings after they have been liberally painted with armalac or a similar compound.

The legs with the windings on may then be set on end and the 3 by 6 pieces of steel inter-leaved in order to complete the magnetic circuit. One end of the core complete is shown in Fig. 139. A slight tapping with a light hammer will set up the irons.

The Mounting.—The mounting is clearly shown in Fig. 148 as is also the directions of the windings. The builder should determine this very carefully by placing the cores end to end before assembling and then noting which terminals of the windings, when connected together, will produce a continuous winding in one direction throughout.

The copper ribbon taps are soldered to No. 10 flexible stranded conductor on the primary and to three No. 4 flexible stranded cables in multiple on the secondary. The cables are lead to binding posts on the primary end and massive copper bolts on the secondary. The connections between the halves of the windings are made with strips of copper insulated with tape.

Welding Experiments.—The current delivered by the

transformer just described is of low voltage but great volume. Such a current may be applied to the requirements of the popular science entertainer in a number of ways and the space available in this treatise will permit of but a brief outline of the many interesting experiments it is possible to produce.

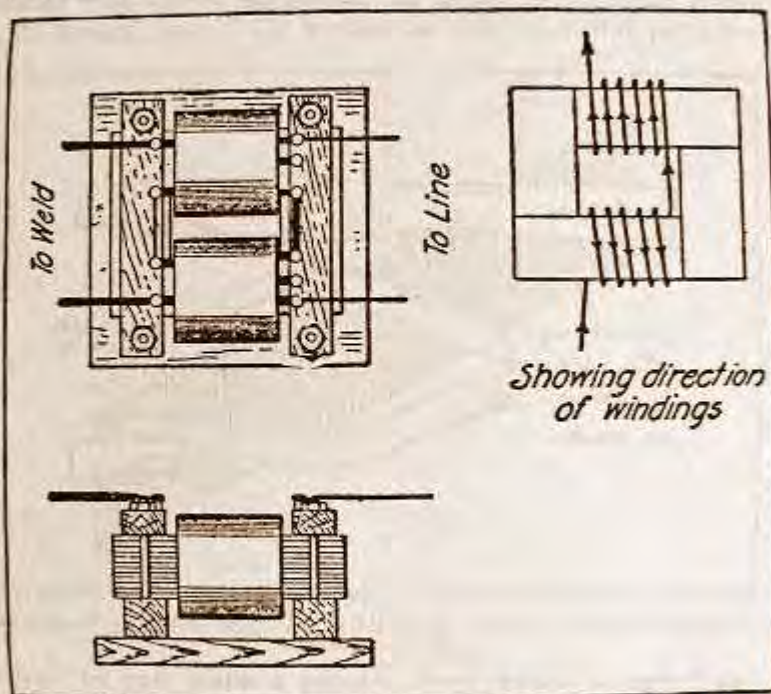

Fig. 148.—The transformer complete showing diagram of connections

As a necessary adjunct to the transformer described previously may be mentioned a pair of heavy cables to conduct the current from the secondary of the transformer to the appliances with which the experiments are to be performed. Such cable may be purchased in an electrical supply store, but it is likely to be rather too stiff for the re-

quirements of the performer. For this reason the author suggests that the worker make his own cable, and the appended illustration (Fig. 149) shows how this may be done. A coil of No. 24 bare copper wire is cut into sufficient ten-foot lengths to make up two bundles of wire each $\frac{1}{4}$ inch in diameter when the wires are tightly bound together. The end of one bundle of wires is forced into a substantial lug and very carefully soldered to insure that a perfect electrical connection is made. This lug is then gripped in a vise and the wires are stretched individually and collectively along the bench with the ends held securely

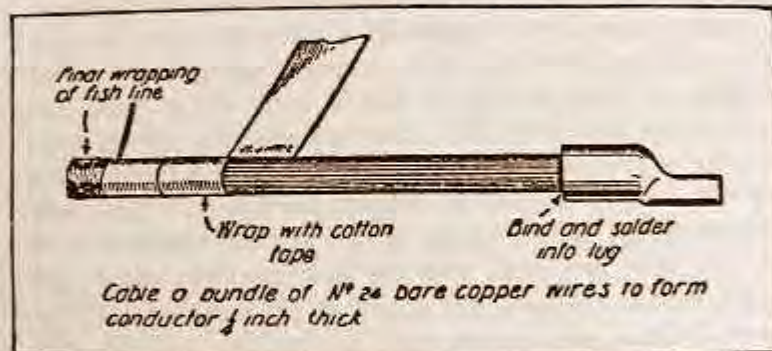

Fig. 149.—Showing construction of cable to carry the heavy secondary current when the stretching has been done. A wrapping of cotton tape is then wound throughout the entire length of the cable starting at the end with the lug and finishing temporarily three or four inches from the other end where the tape is bound with wire to keep it from unwinding. Again starting at the lug end, a layer of fine, hard fish line is wound around the cable and over the tape, finishing the covering of the cable. Before cutting the tape and line at the finishing end the wires are to be cut off squarely and inserted into a second lug which is carefully soldered as in the case of the first one. The tape and line may then be

brought up to the lug and finished off. The same process is repeated with the second bundle of wires to form a cable similar to the first.

The only other adjuncts necessary for the simpler experiments with the transformer are two pairs of tongs or clamps to which the cables are fastened. In Fig. 12 the reader will note a suggestion for a pair of tongs of suitable design, and if the worker is a fairly skilful pattern-

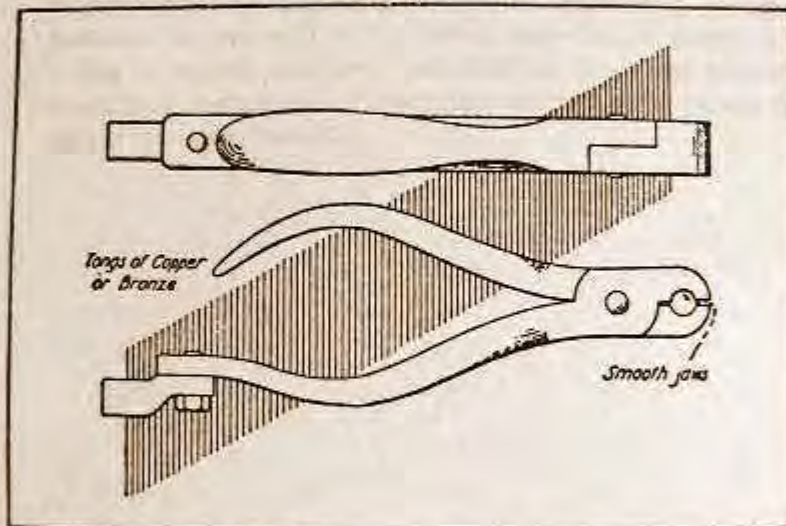

Fig. 150.—These copper tongs are useful in the conduct of many experiments alternating current

maker he can make a pattern from which a copper or bronze casting may be made. Failing in this, he may use a dismantled pair of iron tongs or gas pliers for the patterns, making such changes as may be necessary with the aid of a bit of hard wax. The illustration is just one-half the size of the finished tongs used in the author's outfit, and it will not be safe to use a lighter weight of copper as the tongs heat up pretty well after the current has been on

a few minutes. The lug of the cable is fitted to the handle of the tong as shown in the illustration.

Assuming that the transformer has been set up, the worker will be anxious to try it out. The tongs may be grasped with the bare hands as the voltage of the secondary is so low that practically no shock will be perceptible; however, if the performer's hands are tender or susceptible to perspiration, the handles of the tongs may be dipped in white lacquer which will be quite invisible when dry but which, at the same time, acts as an effective insulator. The tongs having been connected to the transformer secondary by means of the cables and the 60-cycle alternating current circuit through a 30-ampere fused switch, the performer may grasp a piece of $\frac{1}{4}$ -inch steel rod about two feet long in the jaws of the tongs and have an assistant turn on the primary current. The steel will quickly discolor and become gradually red and then white hot. At this stage the current should be turned off and the performer should place a pair of gloves on his hands, explaining to the audience that, as they have just seen, the current passing through his hands has no effect whatever upon him, but that the intense heat so near his hands is worse than unpleasant. The heavy gauntlet gloves in place, the experiment can be carried to the stage of white heat, at which point the steel is almost plastic and the rod can be bent easily into a U shape. A few minutes more and the steel actually burns up in the performer's hands, sending forth a shower of sparks in all directions. In order to protect the eyes and clothing from the sparks, it is well to wear a helmet and a large leather apron to completely cover the person. This dress has its psychological effect upon the audience also.

The transformer may be used to weld together two pieces of iron rod held in tongs and brought together; spot

welding of sheet iron may be done if a device is built to provide sufficient pressure at the contacts; a mass of metal may be brought almost to the melting point if placed in a crucible and the terminals inserted; and, in fact, countless other experiments, many of which will suggest themselves to the possessor of the transformer, may be performed.

A most effective stage setting is one of dark purple velvet in the form of a cavelike affair. Practically all of the electrical experiments should be performed in semi-darkness in order that the effect may be striking. The fusing of copper and zinc rods held in the tongs with the stage dark makes one of the most starting experiments the author has ever beheld.

CHAPTER XXIII.

HINTS FOR THE ELECTRICAL ENTERTAINER.

Not the least important feature of the work in hand is the preparation of a suitable explanatory lecture to accompany the experiments which are to be performed with the apparatus described. Upon the snap and vigor of the lecture depend in a large measure the successful presentation of the offering. It is safe to assume that the day of the electrical fakir is past—no longer can the smooth-tongued performer claim some supernatural power which enables him to take through his body enormous voltages which would prove fatal to the average mortal. The lecturer of this type is as much a thing of the past as is the old-time magician who makes claim to some occult power rather than to sleight-of-hand or mechanical ingenuity to accomplish his tricks. The electrical entertainer of to-day must bear in mind that in the past five years the education of the general public along the lines of electricity and science has advanced in an astonishing degree, and to offer his experiments under the guise of a wizard is not only to insult the intelligence of his audience, but to stamp himself as an absurd charlatan as well. Just as the modern prestidigitator credits his quickness of hand, so should the electrical entertainer give credit to modern science for his ability to perform the startling experiments he offers.

Class of Audience.—The class of audience catered to should also bear careful consideration. The style of talk favored by the intelligent and well-read Chautauqua as-

sembly would be hopelessly out of place in even a high-class vaudeville theatre. This is not due to the lesser degree of intelligence to be found in the theatre audience so much as to the fact that such an audience demands to be shown rather than told. The experiments must speak for themselves and any lecture accompanying their presentation must be more in the nature of an explanatory "chatter" rather than a discourse on the theory and scientific reasons for the phenomena demonstrated. With the typical lecture audience, on the other hand, the explanatory remarks may be more comprehensive in nature, as such an audience comes to listen and be instructed, as well as to see and be entertained. At the same time the performer must not lose sight of the fact that many of the people in even a scholarly audience are totally unfamiliar with even the fundamentals of electricity except in a vague way, and his discourse should therefore be interspersed with frequent analogies in everyday life in order that the terms and phrases used may be clearly comprehended.

A clever touch of comedy is of almost inestimable value; for the theatre audience it should be of the "slapstick" variety, while for the lecture assembly it should be genteel or even subtle in nature. As an illustration of the former style of comedy, the writer has seen many a mediocre electrical act carried through to a riotous curtain simply because a handful of boys from the audience were knocked off their feet supposedly through contact with a wire. The same bit of comedy presented for the approval of a more cultured audience would have resulted in a few disdainful smiles.

Short Introduction Preferable.—The performer should beware of a lengthy introduction in either of the two cases. For the theatre, the opening remarks should be exceedingly brief and "straight from the shoulder," for an audience of

this nature is ever impatient for something to happen and the quicker the action throughout the better the reception. If the lecturer is endowed with an unusually commanding presence, which invariably combines the gift of wit or humor, he may carry the action with his own magnetic personality; but for the individual who is not gifted in this manner, the rapid-fire style is safer and less likely to subject him to the disconcerting ridicule of an unruly gallery crowd.

Impressive Opening Imperative.—The introductory remarks should be quickly followed up with an impressive experiment; this is to at once arrest the attention and whet the appetite for better things to come. After the successful completion of this one experiment, the performer has, in a large measure, gained the confidence of his people, and in consequence, they will be the more ready to listen to his further remarks. At this point may come the real introduction to the entertainment to follow. The experiments should be placed on the programme in logical order and every effort made to so arrange them that there shall be no wait whatever between the successive demonstrations.

The mediocre experiments should be interspersed with the spectacular and startling ones, and invariably the climax should consist of the one experiment that proves to be the masterpiece. It is not always possible to determine just which one from among the number may properly lay claim to this title and this is where the value of "trying it on the dog" comes in. As a matter of fact the final rehearsals of the performance should be before a real audience and a critical one at that, for only in this way can the production be whipped into shape.

Selection of Experiments.—The selection and preparation of the experiments to be used in his program must needs rest with the entertainer himself. The work must

show the individuality of the entertainer, since he is to perform the experiments and is responsible for their reception by the audience. The hints offered in this book should, therefore, be considered in the light of suggestions only, and the most the writer can hope is that they will start the entertainer on the right track. Constant experiment day after day will serve to bring out the wonderful possibilities in the apparatus, and as the worker proceeds he should make note of the effects produced and strive in future attempts to make the manner of presentation more striking and interesting. The one big thing to be borne in mind, as outlined in the last article, is that the experiments must hold the interest of the audience without the necessity of discourse or explanation. In the first place, the high frequency discharge produces a deafening noise which in itself renders speech inaudible while the coil is in operation, and, secondly, the audience as a rule does not care what the entertainer has to say and it must be shown. Simplicity should be the keynote throughout, for the average theatre audience may be treated as a more or less unruly crowd of children who want solely to be amused and entertained. With these facts in mind, the entertainer may plan his program. The number of experiments is seemingly limitless when one starts to operate the apparatus, and as the time allotted the average feature act in vaudeville is from twenty to thirty minutes, it is obvious that only the pick of the lot should be chosen. Some may be selected for their beauty, but the majority should be picked with a view to their sensational qualities.

Probably the most effective opening number is produced by the high frequency transformer in operation at full power with a dark stage. The streamers of fire leap out for several feet in all directions from the ball atop the transformer. The discharge makes a tremendous crackling

and crashing noise which impresses the audience through its weirdness even before the curtain rises. As the curtain ascends, the center of the stage appears to be filled with a twisting, darting mass of slender, purplish fingers of fire which snap at the entertainer as he enters through the center door and walks down stage or toward the footlights. The current may, at this time, be shut off and the lights turned on full for the opening remarks which were discussed in a preceding paragraph.

After the short preliminary address the performer may briefly explain to the audience how modern science enables man to make electricity his servant, and a servant whose services are to be respected but not feared. For instance, he can say that if he were to place his hands across the terminals of the low frequency transformer (pointing out the instrument, but not explaining its principles) he would receive a shock that would positively be fatal, since its voltage is in excess of that used in the electric chair. He may then go on to say that through a simple process of conversion which changes the nature of the current but which does not in any way materially reduce its strength, and which, indeed, serves to increase its voltage to near or quite the million mark, he is enabled to apply that erstwhile destructive force to the good of mankind, curing diseases, relieving pain and in countless other ways fulfilling the claim that electricity is man's greatest servant when intelligently handled. The performer may then show how the tremendous current can be taken through the body without danger, even though its voltage is hundreds of times that used for purposes of electrocution. A metal rod is grasped in the hands, and while standing on an insulated stool the performer approaches the ball discharger of the transformer with the lights out and the coil in operation. As the rod nears the ball, a beautiful halo or luminous

vapor gathers at the point and increases in intensity as the distance is shortened. Finally, when the rod is within four or five feet of the ball, an enormous sheet of purplish-white flame crashes across the intervening space and into the rod held in the hands. The spark leaps into the air and breaks as the heat causes it to rise, and the moment the discharge is broken another flame takes its place. If the distance is shortened to within six inches or a foot of the ball, a piece of stick or bit of paper held in the spark will be ignited immediately.

The performer may then withdraw and have the current turned off for a few words of explanation. The next experiment may be made to show that the current is actually going into the body of the entertainer. To this end, he approaches the ball with his rod held in one hand and in the other he grasps an electrode to which is connected a wire leading to one terminal of an incandescent lamp. The other terminal of the lamp is attached to a second electrode which is held by the assistant. When the current is turned on the spark leaps to the rod as before and the lamp is lighted to full incandescence or even burned out by the current passing between the bodies of the performer and his assistant standing nearby.

Some of the most startling and spectacular experiments of which the high frequency apparatus is capable are produced in connection with the insulated stool and the charged body of the performer. For most of these experiments, the frequency of the current should be increased by moving the primary clip of the oscillation transformer to a point where fewer turns are included in the circuit. This will reduce the spark length of the coil, but this loss can be tolerated in view of the fact that the current is smoother and the muscular contractive effects are totally missing. It is difficult for the performer to do justice to his experi-

ments if he experiences any degree of shock, which, while not at all dangerous, is still disconcerting.

The performer stands on the stool and touches the discharge ball of the coil with his metal wand. When the current is turned on, a strong, snapping spark several inches in length may be drawn from any portion of the body by the assistant. This spark will ignite a piece of cotton dipped in alcohol, light a cigarette, puncture a thin piece of glass, and do many other equally interesting tricks. If the spark is taken from the bare skin for any length of time, a blister will form from the burn which results, and it is therefore advisable to draw the spark from a heavy ring worn on the performer's free hand. An occasional spark taken for a few seconds at a time will not affect the skin and the lighting of the cotton may be accomplished by the assistant bringing the material in close proximity with the performer's ear or chin. *Care should be taken to avoid sparks near the eyes.* If the performer holds a metal spoon in his mouth, a spark may be drawn from the handle and this experiment seldom fails to bring applause.

If the primary clip on the oscillation transformer is carefully adjusted after the performer has been connected with the discharge ball, a point will be found where his body seems literally to exude a luminescent halo of bluish white fire. When the free hand is raised directly over the head, little tongues of fire dart from the finger tips into the air. When a second person approaches to within a foot or so of the performer the space between their bodies is apparently filled with a luminous vapor, and a finger pointed at the performer instantly calls forth an intense, cone-shaped stream of light. A Geissler or other vacuum tube brought to within even six or eight feet of the charged body lights up with its characteristic glow, and, when it approaches to within a foot of the body, the glow

is practically as bright as it would be if the current were passing into it through a wire instead of through space.

An entertaining experiment is to bring an incandescent lamp bulb, held by its base in the assistant's hand, close to a rod held in the hand of the performer. The current slowly strikes through the glass wall, and, as the fracture increases, the air is let into the bulb. As the vacuum lowers the color of the glow in the bulb changes from bluish white to red, then to purple and finally it disappears as the spark punctures the wall and finds its way to the wires inside.

No further attempt will be made to describe "experiments" for to do so is futile at this point. The worker will find that every time he turns the current on, he finds some new wrinkle or stunt to do with the spark. Ardent experimentation with the apparatus itself is the very best teacher and a day spent merely in "playing" with the outfit will give the ingenious worker scores of fascinating experiments, some of which are suitable for the stage and others for the parlor or the laboratory.

Dr. Tesla prepared a series of intensely interesting lectures some years ago and his work, now in book form, offers a truly remarkable series of instructive experiments. While Dr. Tesla advocates, in his book, the use of a high frequency alternator or else an oil-immersed oscillation transformer, still many, if not all, of the performances he pictures can be shown with the apparatus described in this book.

TRANSFORMER DATA

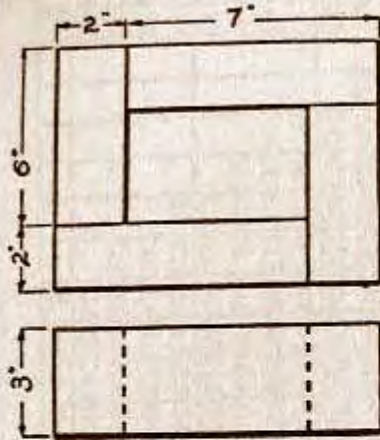

CORE FOR
ALL
FREQUENCIES

110 VOLTS

CYCLES	PRIMARY	SECONDARY
25	250 TURNS No 12 D.C.C.	16,800 TURNS No 30 ENAM.
60	125 No 10 "	8400 No 28 "
125	63 No 10 "	4200 No 28 "

HIGH FREQUENCY APPARATUS

WEIGHT & SORT IRON WIRE COILS

DIAMETER	4'	5'	6'	7'	8'	9'	10'	11'	12'	13'	14'	15'	16'	17'	18'	20'	22'	24'	26'	28'	30'	32'	34'	36'	
1 1/2"	57	53	100	117	133	150	167	183	217	233	25	267	283	3	333	367	4	433	467	5	533				
1 3/8"	54	106	127	148	169	190	211	232	253	274	295	317	338	359	380	422	464	506	548	591	633	675	717	759	
1 1/4"	104	130	156	182	208	234	26	287	313	339	365	391	417	443	469	495	521	547	573	599	625	651	677	703	
1 3/16"	186	186	189	221	252	284	315	347	378	410	441	472	504	535	567	598	629	660	691	722	753	784	815	846	
1 1/4"	150	187	225	262	3	337	375	412	45	487	525	563	6	637	675	713	751	789	827	865	903	941	979	1017	
1 5/16"		220	264	308	352	396	440	484	528	572	616	66	704	742	780	818	856	894	932	970	1008	1046	1084	1122	
1 3/8"		255	306	357	408	459	511	562	613	664	715	766	817	868	919	970	1021	1072	1123	1174	1225	1276	1327	1378	
1 7/16"		322	410	498	587	676	764	852	940	1028	1116	1204	1292	1380	1468	1556	1644	1732	1820	1908	1996	2084	2172	2260	
2"		4	467	733	6	667	733	8	867	934	10	107	113	12	123	13	134	14	145	15	156	16	167	17	
2 1/8"			527	602	677	753	828	903	979	1055	1131	12	128	135	141	148	155	161	168	174	181	188	194	201	
2 1/4"			591	673	756	844	928	1011	11	118	127	135	143	152	160	169	177	186	194	202	211	219	227	235	
2 3/8"			727	849	970	1090	1211	1332	1453	1574	16	168	180	192	204	216	228	240	252	264	276	288	301	313	
2 1/2"			833	987	1141	1295	1449	1603	1757	1911	20	212	225	238	251	264	277	290	303	316	329	342	355	368	
2 5/8"			1031	1241	1451	1661	1871	2081	2291	2501	26	272	285	298	311	324	337	350	363	376	389	402	415	428	
2 3/4"			1121	1361	1601	1841	2081	2321	2561	2801	29	297	310	323	336	349	362	375	388	401	414	427	440	453	
2 7/8"			1281	1561	1841	2121	2401	2681	2961	3241	33	339	352	365	378	391	404	417	430	443	456	469	482	495	
3"			15	165	18	195	21	225	24	255	27	285	30	315	33	345	36	375	39	405	42	435	45	465	

INDEX

A	
Alternating Current	15
Alternative Current, period of	16
Alternators	17
Ammeter, Hot Wire	160
Apparatus, Electro-thera- peutic	127
Apparatus, Induction Coil..	71
Apparatus, installation of ..	198
C	
Cabinet	152
Characteristics of High Fre- quency Current	20
Circuits, Oscillatory	34
Coil Construction, Induction	74
Coil, Oudin	61
Coils, Induction	47
Coils, Kicking	48
Coils, Proportion of	63
Coils, Tesla	106
Condenser	31
Condenser Discharge Gen- erator	28
Condensers, High Potential	49
Condensers, Mica	53
Condensers, Moulded	53
Conductive Electrical Enter- tainments	256
Connection	158
Connections	111
Construction of Large Ap- paratus	218
Construction of Spark Gap	190
Core	101
Core Volume Transformers	41
Cultivation, High Fre- quency Current	182
Culture, Plant	172
Current	29
Current, Alternating	15
Current, High Frequency ..	19
Cycle	16
D	
D'Arsonval Oscillation Transformer	143
Data, Transformer	264
Design of Induction Coils..	47
Design of Transformers...	40
Direct Current Outfits.....	129
E	
Electrical Apparatus for the Stage	212
Electrical Entertainments, Conducting	256
Electroculture Methods ...	173
Electro-Therapeutic Outfits, Operation of	166
Electro-Therapeutic Work..	98
Experiments, Selection of..	258
Experiments, Welding	250
F	
Frequency of Generators..	17
G	
Gap, Quenched Spark	56
Gap, Rotary	55

- Generation of Ozone 23
 Generation of X-Rays 23
- H**
- High-Frequency Current .. 19
 High-Frequency Current,
 Characteristics of 20
 High-Frequency Current
 Cultivation 182
 High-Frequency Current
 in Medicine 22
 High Potential Condensers 49
 High Potential Tesla Cur-
 rent 170
 High-Potential Transformer 31
 Hot-Wire Ammeter 160
 How High-Frequency Cur-
 rent is Produced 27
- I**
- Improvised Winding Ma-
 chine 148
 Inclosed Spark Gap 230
 Induction Coil Apparatus.. 71
 Induction Coil Construction 74
 Induction Coil Design 47
 Induction Coils 47
 Installation of Apparatus.. 198
 Insulation, Secondary 66
 Interrupter 80
- K**
- Kicking Coil Apparatus.... 85
 Kicking Coil Method of
 Producing High-Fre-
 quency 29
 Kicking Coil Outfit 126
 Kicking Coils 48
- L**
- Large Apparatus, Construc-
 tion of 218
 Large Portable Outfits ... 130
 Large Tesla Coils 239
- M**
- Magnetic Leakage Trans-
 former 36
 Mica Condensers 53
 Motor-Generators 18
 Moulded Condensers 53
- N**
- Notes on Plant Culture 204
 Number of Poles on Gener-
 ators 17
- O**
- Office Equipment Made
 with Standard Materials. 145
 Office Equipment, Physi-
 cians 132
 Operation of Electrothera-
 peutic Outfits 166
 Oscillatory Circuits 34
 Oscillation Transformer .. 31
 Oscillation Transformer,
 D'Arsonval 143
 Oudin Coil 61
 Oudin Resonator 245
 Outfit, Kicking Coil 126
 Outfits, Direct Current ... 129
 Ozone, Generation of 23
- P**
- Period of A. C. Current .. 16
 Physician's Portable Appar-
 atus 125
 Plant Culture 172
 Plant Culture, Notes on ... 204
 Plot, Wiring 201
 Poles, Number on Genera-
 tors 17
 Portable Apparatus, Physi-
 cians 125
 Portable Outfits, Large ... 130
 Primary Winding 101
 Proportions of Coils 63

- Q**
- Quenched - Gap Trans-
formers 121
- Quenched Rotary Spark
Gap 58
- Quenched Spark Gap 56
- R**
- Resonator, Oudin 245
- Rotary Gap 55
- Rotary Quenched Spark
Gap 58
- S**
- Secondary Insulation 66
- Secondary Winding 77
- Setting Up Stage Apparatus 236
- Soft Iron Cores, Weight of
(Table) 266
- Spark-Gap 31
- Spark-Gap, Construction of 190
- Spark-Gap Stationary 140
- Stage, Apparatus for 212
- Stage Apparatus, Setting up 236
- Stationary Spark-Gap 140
- T**
- Table (Turns per Linear
Inch) 265
- Table (Weight of Soft Iron
Cores) 266
- Tesla Coils 106
- Tesla Coils, Large 239
- Tesla Current, High-Poten-
tial 170
- Transformer Data 264
- Transformer Design 40
- Transformer, Magnetic
Leakage Type 36
- Transformer, Vacuum Tube
Oscillation 142
- Transformers, Quenched-
Gap 121
- Turns per Linear Inch
(Table) 265
- V**
- Vacuum Tube Oscillation
Transformer 141
- Volume of Cone, Trans-
formers 41
- W**
- Weight of Soft Iron Cores
(Table) 266
- Welding Experiments 250
- Winding Machine, Impro-
vised 148
- Winding, Primary 101
- Winding, Secondary 77
- Wiring Plot 201
- X'**
- X-Rays, Generation of ... 23

Document Outline

- [Page0001](#)
- [Page0002](#)
- [Page0003](#)
- [Page0004](#)
- [Page0005](#)
- [Page0006](#)
- [Page0007](#)
- [Page0008](#)
- [Page0009](#)
- [Page0010](#)
- [Page0011](#)
- [Page0012](#)
- [Page0013](#)
- [Page0014](#)
- [Page0015](#)
- [Page0016](#)
- [Page0017](#)
- [Page0018](#)
- [Page0019](#)
- [Page0020](#)
- [Page0021](#)
- [Page0022](#)
- [Page0023](#)
- [Page0024](#)
- [Page0025](#)
- [Page0026](#)
- [Page0027](#)
- [Page0028](#)
- [Page0029](#)
- [Page0030](#)
- [Page0031](#)
- [Page0032](#)
- [Page0033](#)

- [Page0034](#)
- [Page0035](#)
- [Page0036](#)
- [Page0037](#)
- [Page0038](#)
- [Page0039](#)
- [Page0040](#)
- [Page0041](#)
- [Page0042](#)
- [Page0043](#)
- [Page0044](#)
- [Page0045](#)
- [Page0046](#)
- [Page0047](#)
- [Page0048](#)
- [Page0049](#)
- [Page0050](#)
- [Page0051](#)
- [Page0052](#)
- [Page0053](#)
- [Page0054](#)
- [Page0055](#)
- [Page0056](#)
- [Page0057](#)
- [Page0058](#)
- [Page0059](#)
- [Page0060](#)
- [Page0061](#)
- [Page0062](#)
- [Page0063](#)
- [Page0064](#)
- [Page0065](#)
- [Page0066](#)
- [Page0067](#)
- [Page0068](#)
- [Page0069](#)
- [Page0070](#)

- [Page0071](#)
- [Page0072](#)
- [Page0073](#)
- [Page0074](#)
- [Page0075](#)
- [Page0076](#)
- [Page0077](#)
- [Page0078](#)
- [Page0079](#)
- [Page0080](#)
- [Page0081](#)
- [Page0082](#)
- [Page0083](#)
- [Page0084](#)
- [Page0085](#)
- [Page0086](#)
- [Page0087](#)
- [Page0088](#)
- [Page0089](#)
- [Page0090](#)
- [Page0091](#)
- [Page0092](#)
- [Page0093](#)
- [Page0094](#)
- [Page0095](#)
- [Page0096](#)
- [Page0097](#)
- [Page0098](#)
- [Page0099](#)
- [Page0100](#)
- [Page0101](#)
- [Page0102](#)
- [Page0103](#)
- [Page0104](#)
- [Page0105](#)
- [Page0106](#)
- [Page0107](#)

- [Page0108](#)
- [Page0109](#)
- [Page0111](#)
- [Page0112](#)
- [Page0113](#)
- [Page0114](#)
- [Page0115](#)
- [Page0116](#)
- [Page0117](#)
- [Page0118](#)
- [Page0119](#)
- [Page0120](#)
- [Page0121](#)
- [Page0122](#)
- [Page0123](#)
- [Page0124](#)
- [Page0125](#)
- [Page0126](#)
- [Page0127](#)
- [Page0128](#)
- [Page0129](#)
- [Page0130](#)
- [Page0131](#)
- [Page0132](#)
- [Page0133](#)
- [Page0134](#)
- [Page0135](#)
- [Page0136](#)
- [Page0137](#)
- [Page0138](#)
- [Page0139](#)
- [Page0140](#)
- [Page0141](#)
- [Page0142](#)
- [Page0143](#)
- [Page0144](#)
- [Page0145](#)

- [Page0146](#)
- [Page0147](#)
- [Page0148](#)
- [Page0149](#)
- [Page0150](#)
- [Page0151](#)
- [Page0152](#)
- [Page0153](#)
- [Page0154](#)
- [Page0155](#)
- [Page0156](#)
- [Page0157](#)
- [Page0158](#)
- [Page0159](#)
- [Page0160](#)
- [Page0161](#)
- [Page0162](#)
- [Page0163](#)
- [Page0164](#)
- [Page0165](#)
- [Page0166](#)
- [Page0167](#)
- [Page0168](#)
- [Page0169](#)
- [Page0170](#)
- [Page0171](#)
- [Page0172](#)
- [Page0173](#)
- [Page0174](#)
- [Page0175](#)
- [Page0176](#)
- [Page0177](#)
- [Page0178](#)
- [Page0179](#)
- [Page0180](#)
- [Page0181](#)
- [Page0182](#)

- [Page0183](#)
- [Page0184](#)
- [Page0185](#)
- [Page0186](#)
- [Page0187](#)
- [Page0188](#)
- [Page0189](#)
- [Page0190](#)
- [Page0191](#)
- [Page0192](#)
- [Page0193](#)
- [Page0194](#)
- [Page0195](#)
- [Page0196](#)
- [Page0197](#)
- [Page0198](#)
- [Page0199](#)
- [Page0200](#)
- [Page0201](#)
- [Page0202](#)
- [Page0203](#)
- [Page0204](#)
- [Page0205](#)
- [Page0206](#)
- [Page0207](#)
- [Page0208](#)
- [Page0209](#)
- [Page0210](#)
- [Page0211](#)
- [Page0212](#)
- [Page0213](#)
- [Page0214](#)
- [Page0215](#)
- [Page0216](#)
- [Page0217](#)
- [Page0218](#)
- [Page0219](#)

- [Page0220](#)
- [Page0221](#)
- [Page0222](#)
- [Page0223](#)
- [Page0224](#)
- [Page0225](#)
- [Page0226](#)
- [Page0227](#)
- [Page0228](#)
- [Page0229](#)
- [Page0230](#)
- [Page0231](#)
- [Page0232](#)
- [Page0233](#)
- [Page0234](#)
- [Page0235](#)
- [Page0236](#)
- [Page0237](#)
- [Page0238](#)
- [Page0239](#)
- [Page0240](#)
- [Page0241](#)
- [Page0242](#)
- [Page0243](#)
- [Page0244](#)
- [Page0245](#)
- [Page0246](#)
- [Page0247](#)
- [Page0248](#)
- [Page0249](#)
- [Page0250](#)
- [Page0251](#)
- [Page0252](#)
- [Page0253](#)
- [Page0254](#)
- [Page0255](#)
- [Page0256](#)

- [Page0257](#)
- [Page0258](#)
- [Page0259](#)
- [Page0260](#)
- [Page0261](#)
- [Page0262](#)
- [Page0263](#)
- [Page0264](#)
- [Page0265](#)
- [Page0266](#)
- [Page0267](#)
- [Page0268](#)
- [Page0269](#)